

# MINIATURE SCENERY



Model supplied unpainted and unassembled

## AUTOSHOP

MINIATURE SCENERY MODELS ARE DESIGNED FOR 25MM (1 INCH) BASE MINIATURES, IDEAL FOR GAMERS AND COLLECTORS.

AT [WWW.MINIATURESCENERY.COM](http://WWW.MINIATURESCENERY.COM) WE PROVIDE DETAILED AND EASY TO FOLLOW ILLUSTRATED GUIDES FOR PAINTING TERRAIN.

THE AUTOSHOP IS A LARGE BUILDING WITH A LARGE ROLLER DOOR AND MULTIPLE ROOF ACCESS POINTS.

FOR USE WITH SCI-FI SERIES.

SCIFI BRIDGES CAN BE ADDED TO CREATE WALKWAYS BETWEEN BUILDINGS.

ALL INSTRUCTIONS AVAILABLE ONLINE AT [HTTP://WWW.MINIATURESCENERY.COM](http://WWW.MINIATURESCENERY.COM)

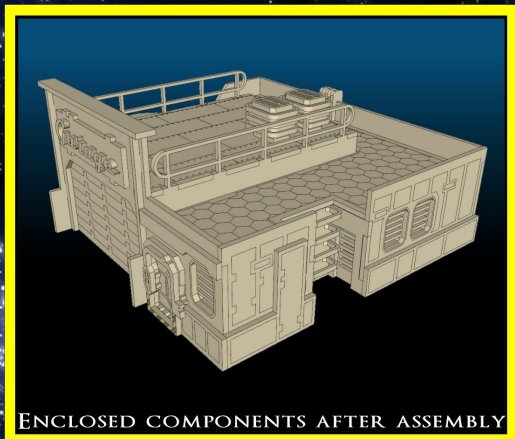

ENCLOSED COMPONENTS AFTER ASSEMBLY

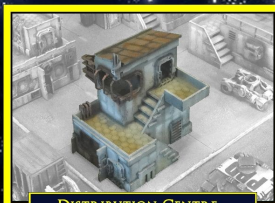

DISTRIBUTION CENTRE

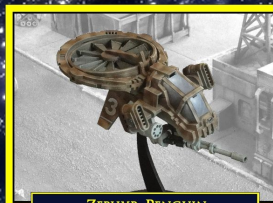

ZEPHYR PENGUIN

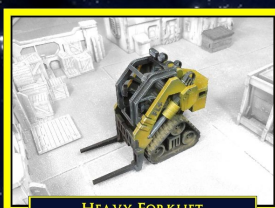

HEAVY FORKLIFT

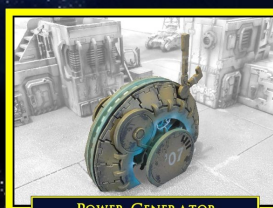

POWER GENERATOR



# CNC WORKSHOP MINIATURE SCENERY

## INSTRUCTIONS

### Autoshop

#### Preparation

Once you clear some table space you will need a hobby knife and glue (PVA, wood glue, hobby glue) and a file or small piece of sandpaper to be used for cleaning up any tiny imperfections.

It's a good idea to familiarise yourself with how the pieces fit together before gluing.

#### Getting Started

- I. Parts should remove easily from the board by pressing through and popping them out. It's a good idea to cut through the tiny joins first though, and some parts (particularly smaller, more detailed parts) may need more careful persuasion.
- II. Use a file or sand paper last to completely remove the tabs that might remain.
- III. Parts may be a very tight fit, slight trimming or sanding of parts may be needed for ease of assembly.

#### Construction

Slot the parts together as shown by the pictures below, applying glue wherever there is a connection.

Allow the model to completely dry before painting it. This is a complex kit with many small parts. Allowing each section to dry thoroughly before heading to the next is strongly recommended.

Some parts of this kit are very fine, or have engraving very close to edges. Make sure you cut through any tabs carefully with a hobby knife first to avoid damage.

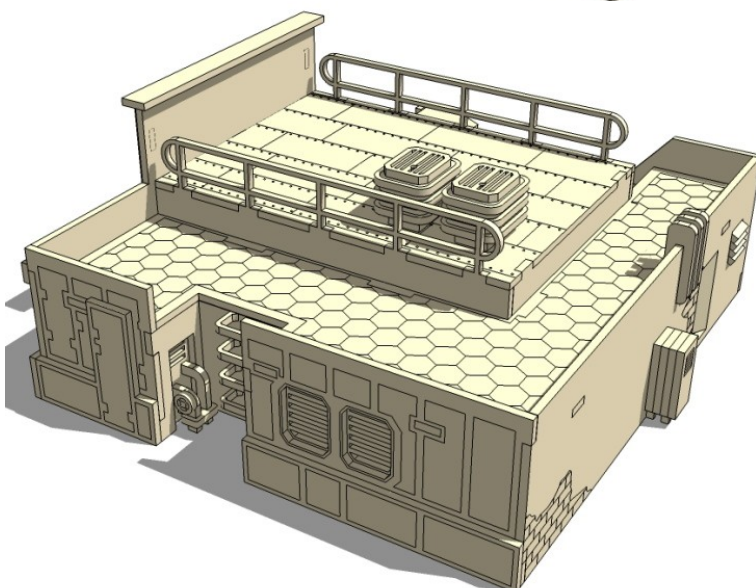
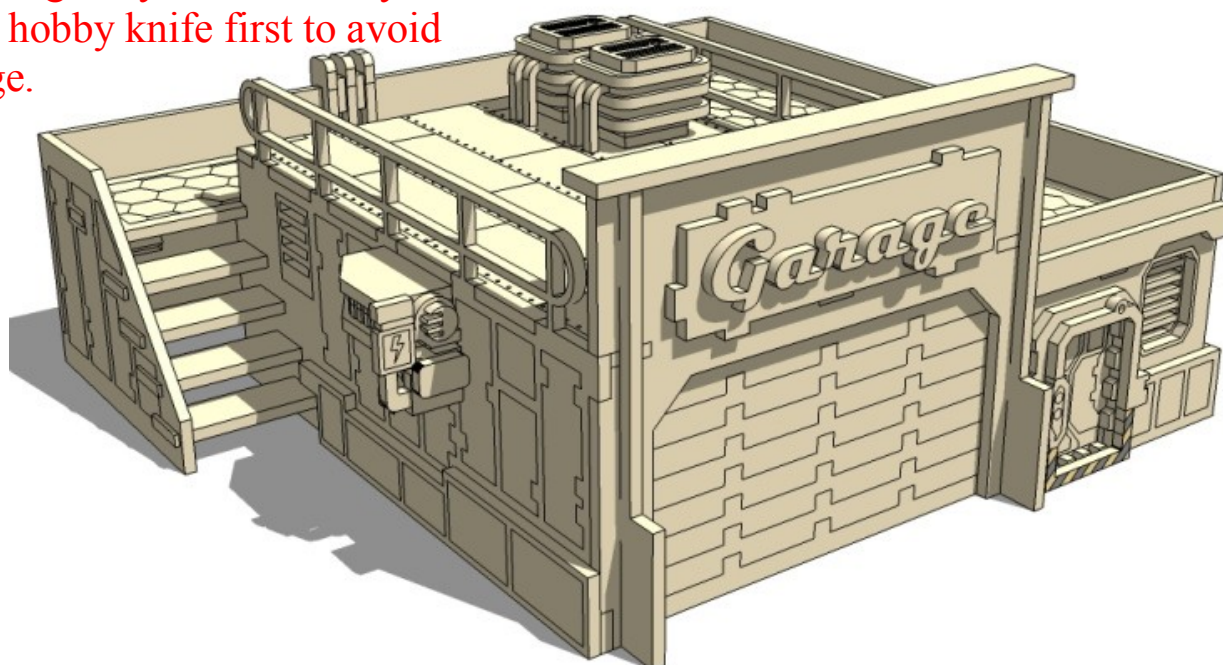

CNC WORKSHOP

# MINIATURE SCENERY

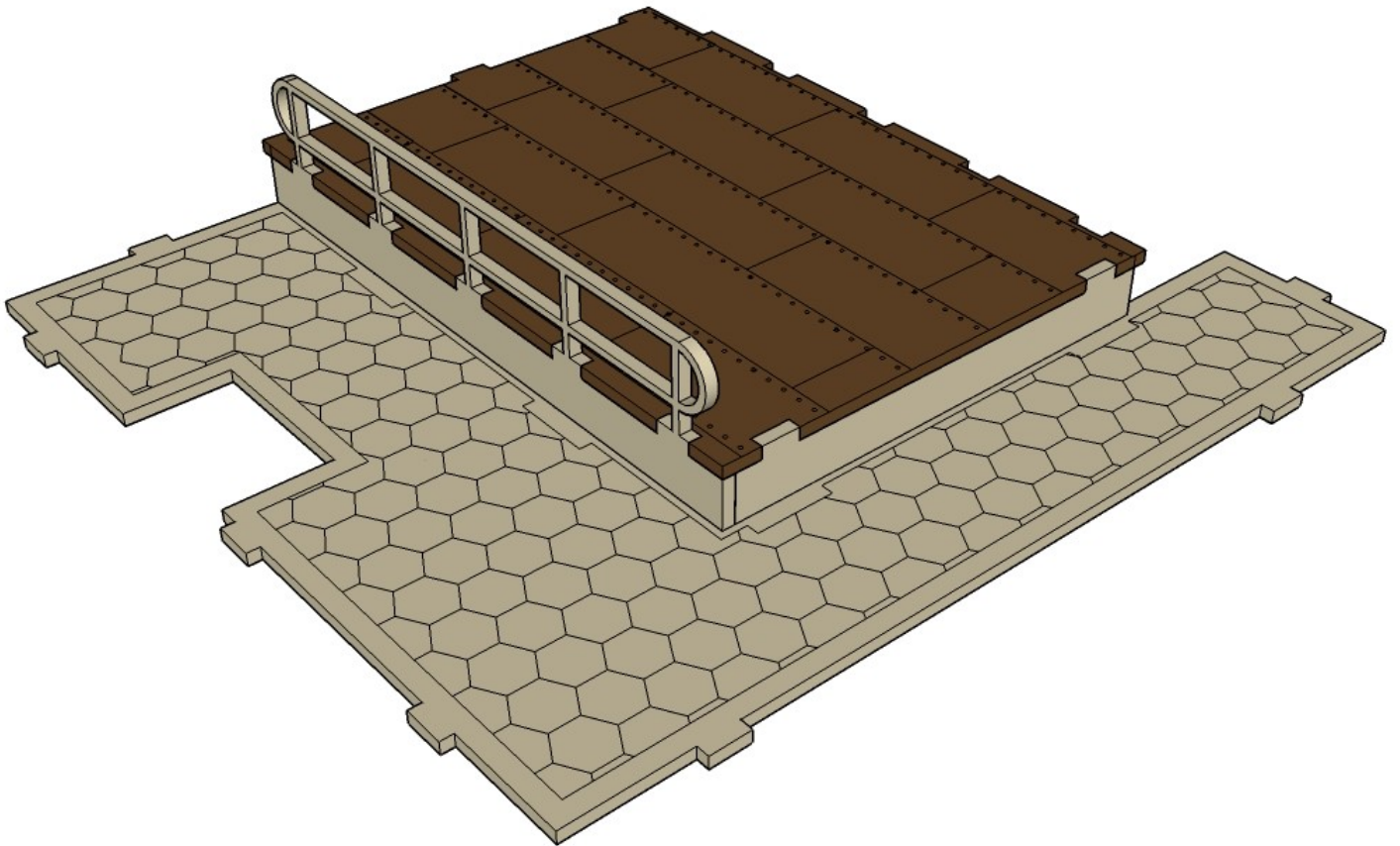

CNC WORKSHOP

# MINIATURE SCENERY

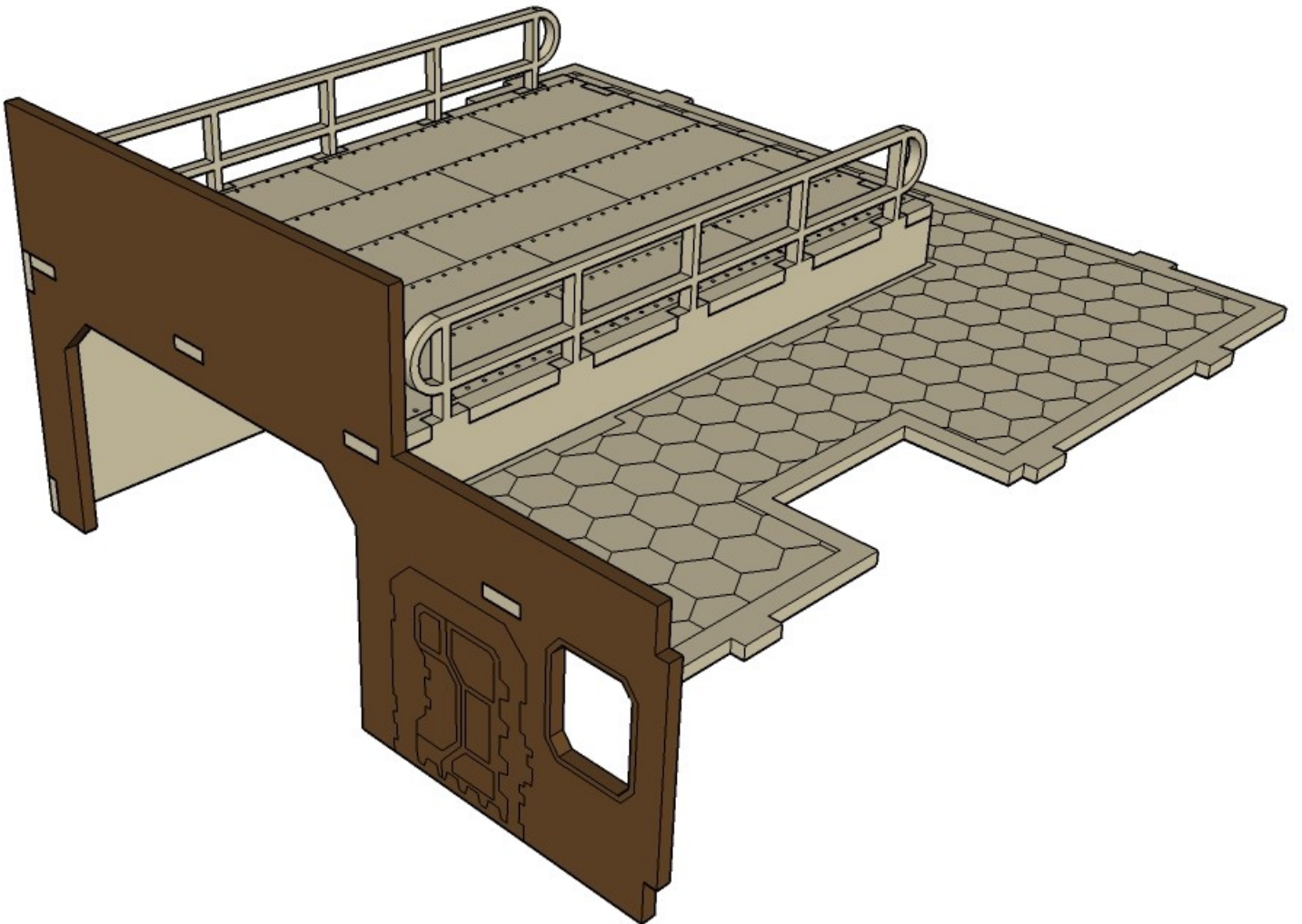
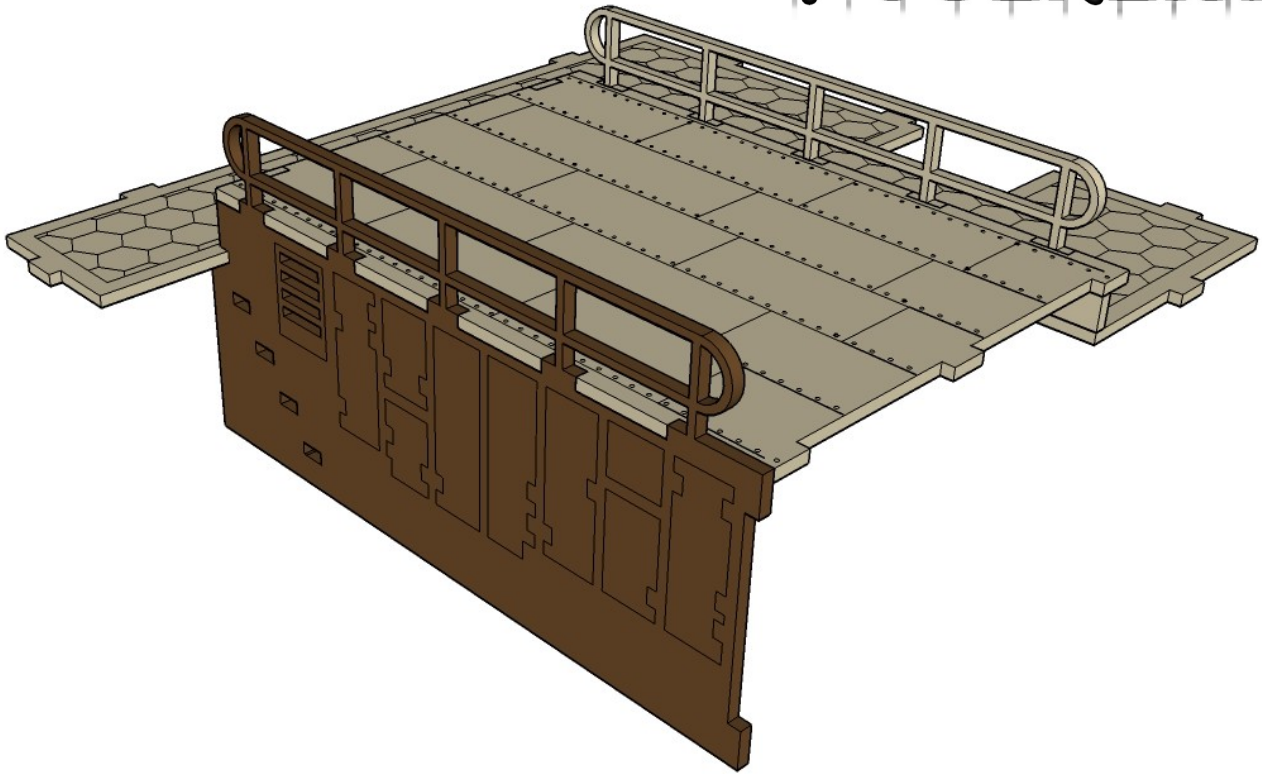

CNC WORKSHOP

# MINIATURE SCENERY

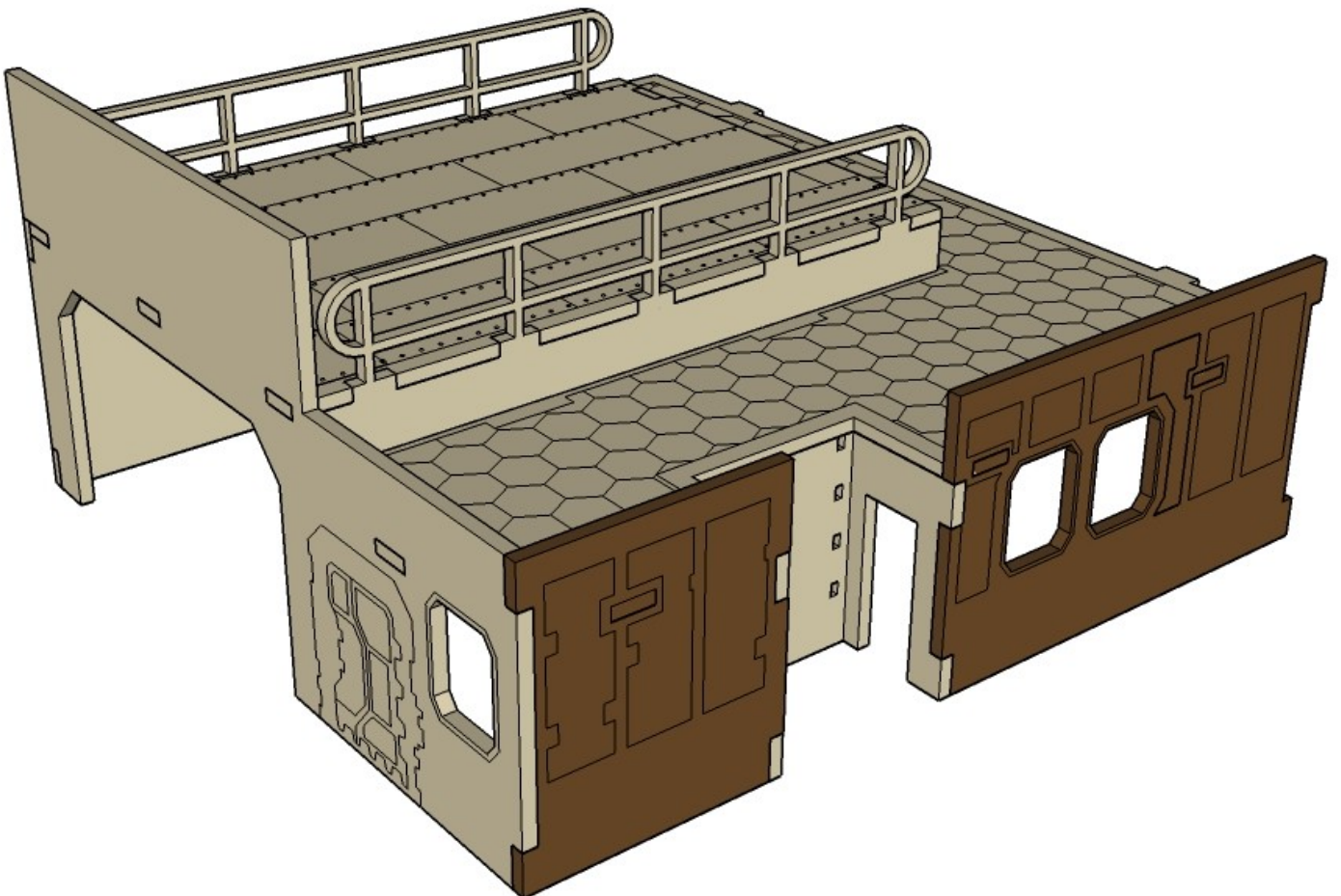
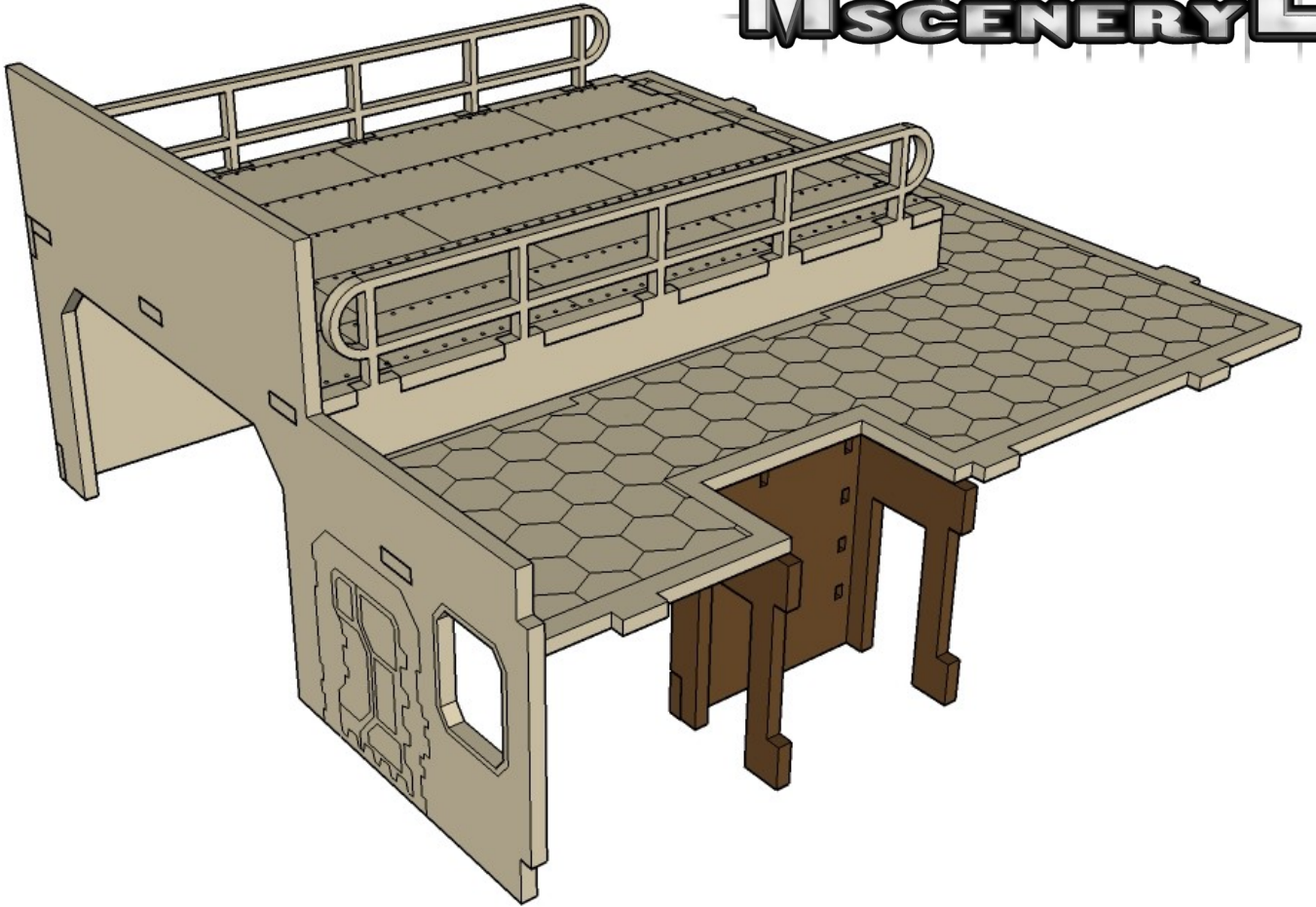

CNC WORKSHOP

# MINIATURE SCENERY

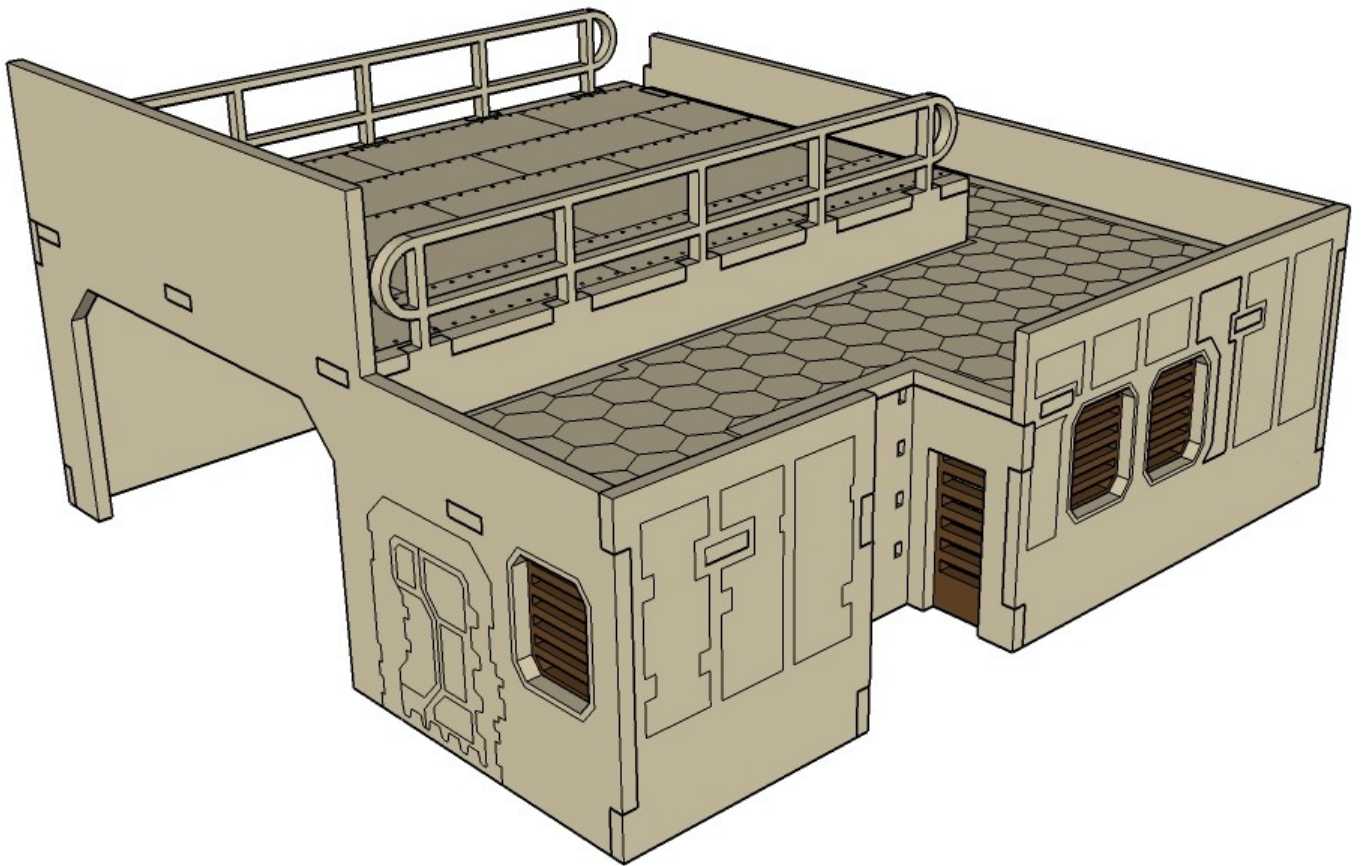
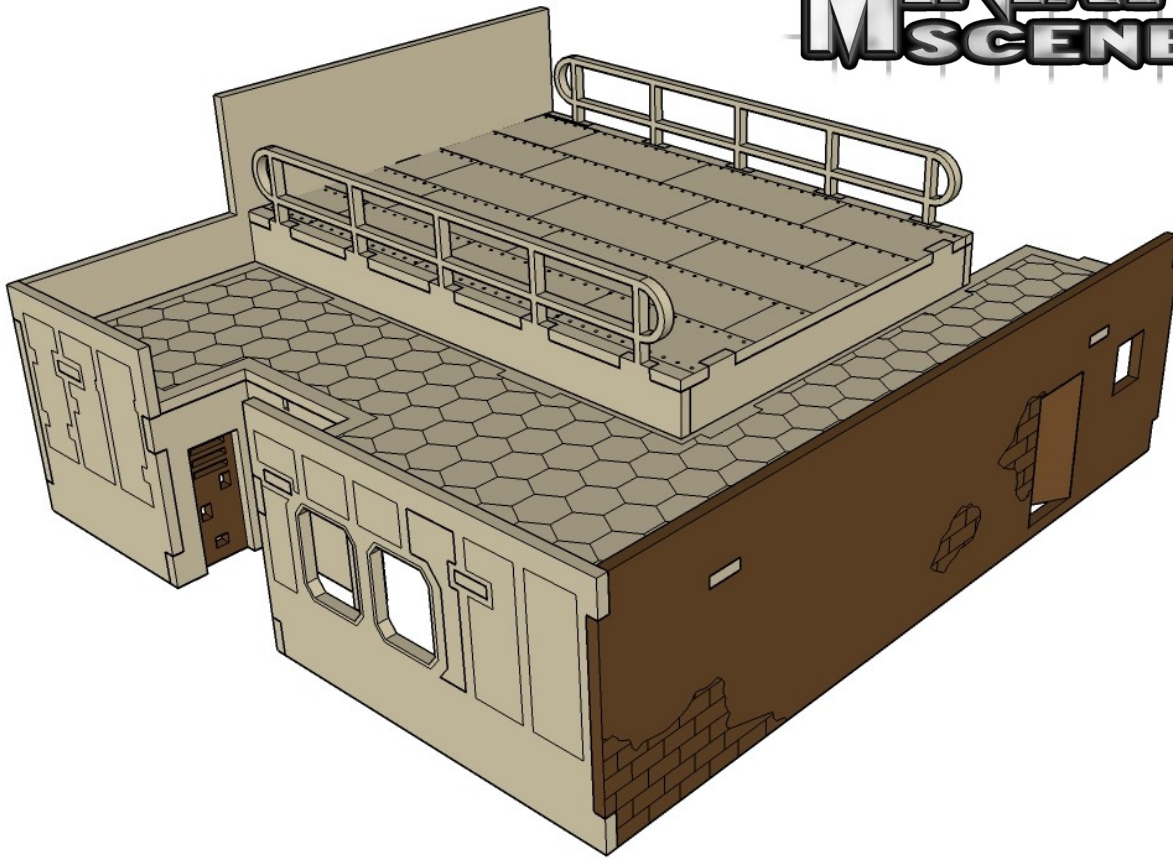

CNC WORKSHOP

# MINIATURE SCENERY

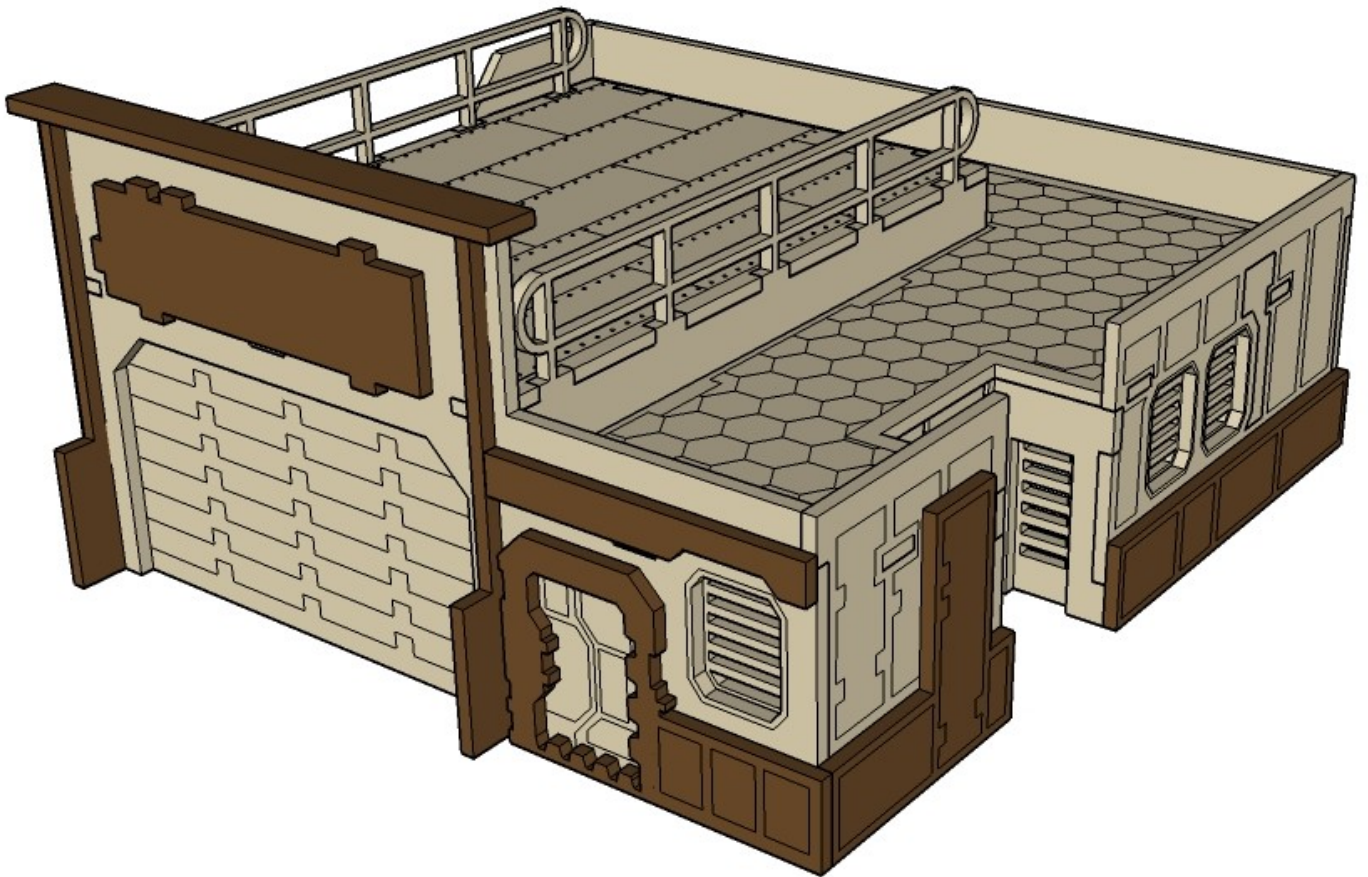
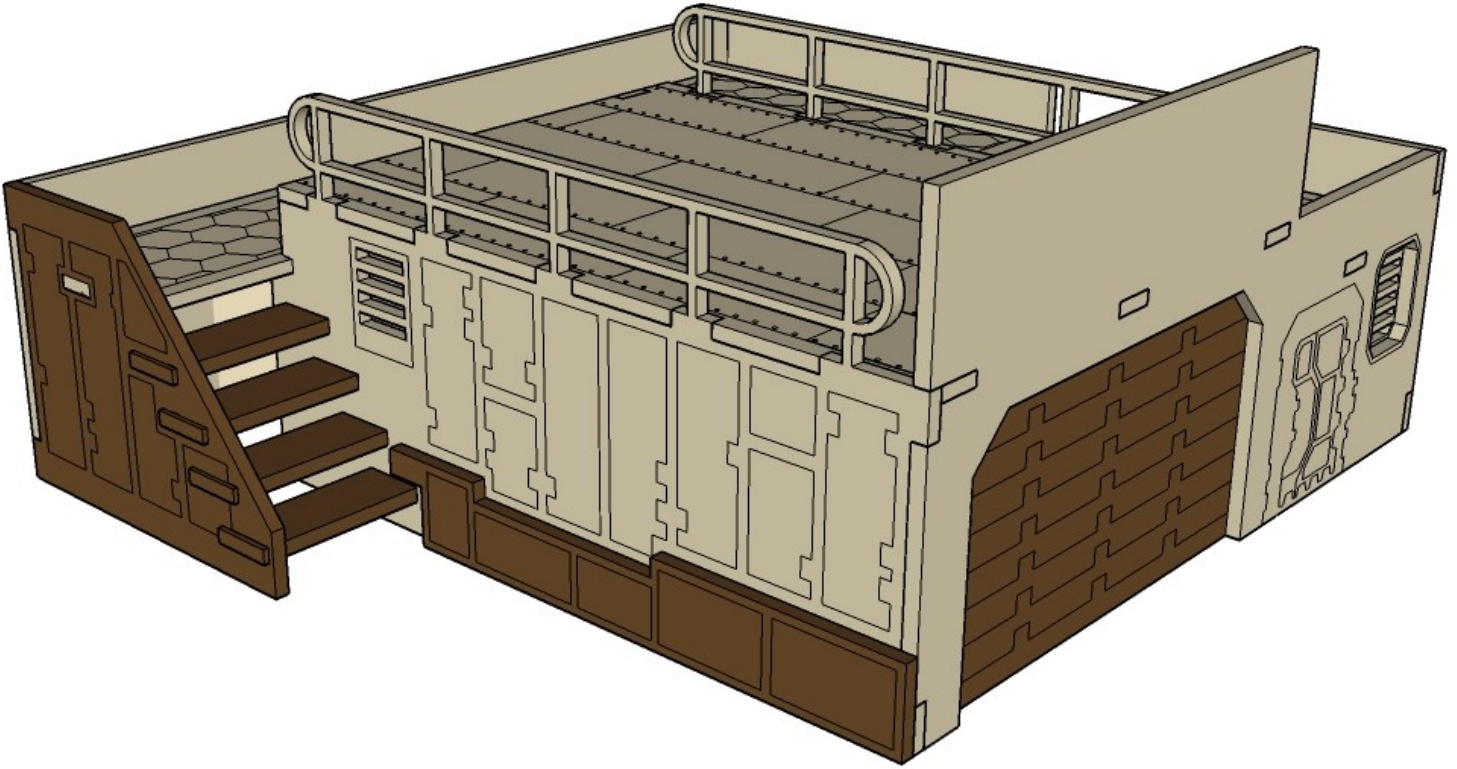

CNC WORKSHOP

# MINIATURE SCENERY

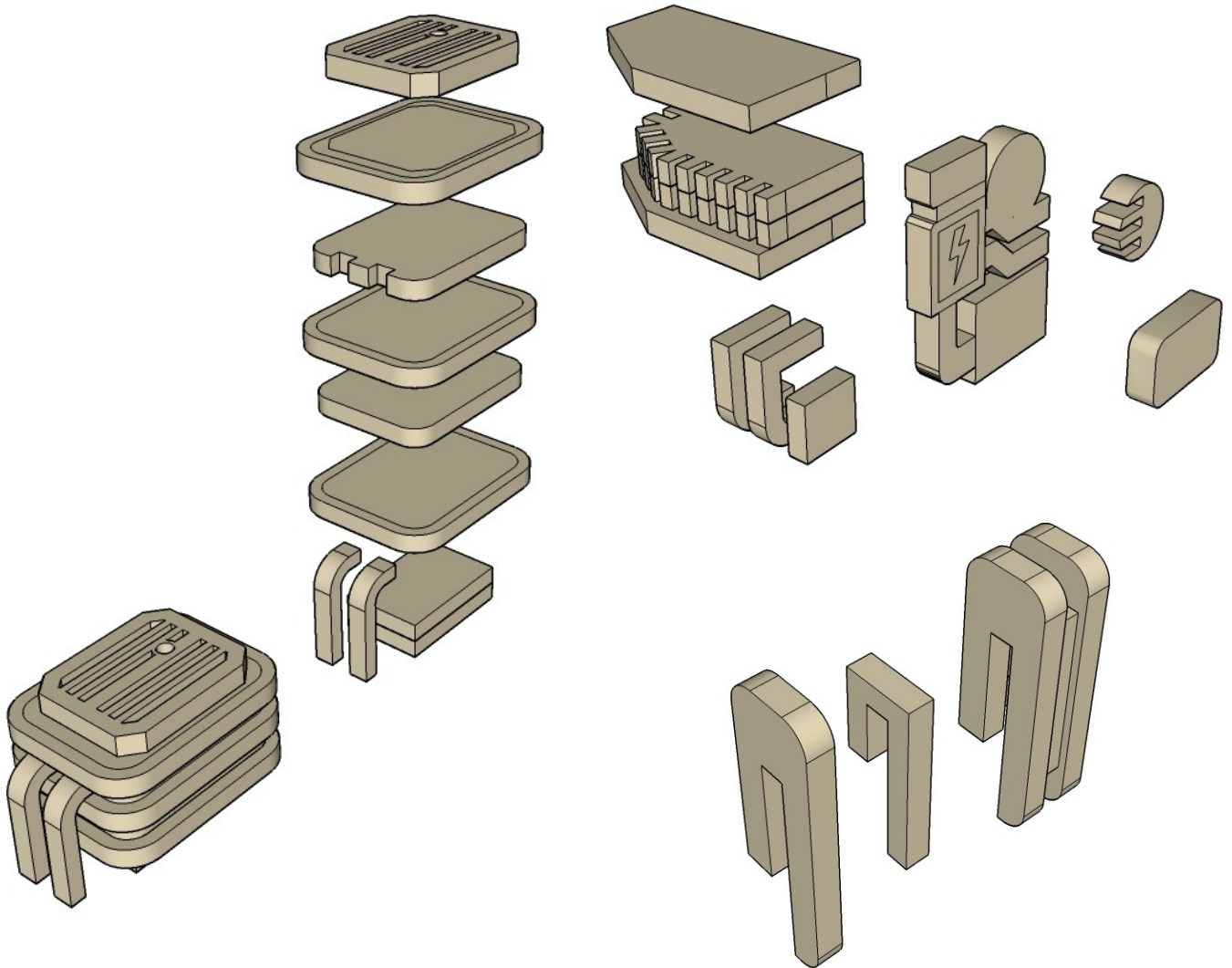
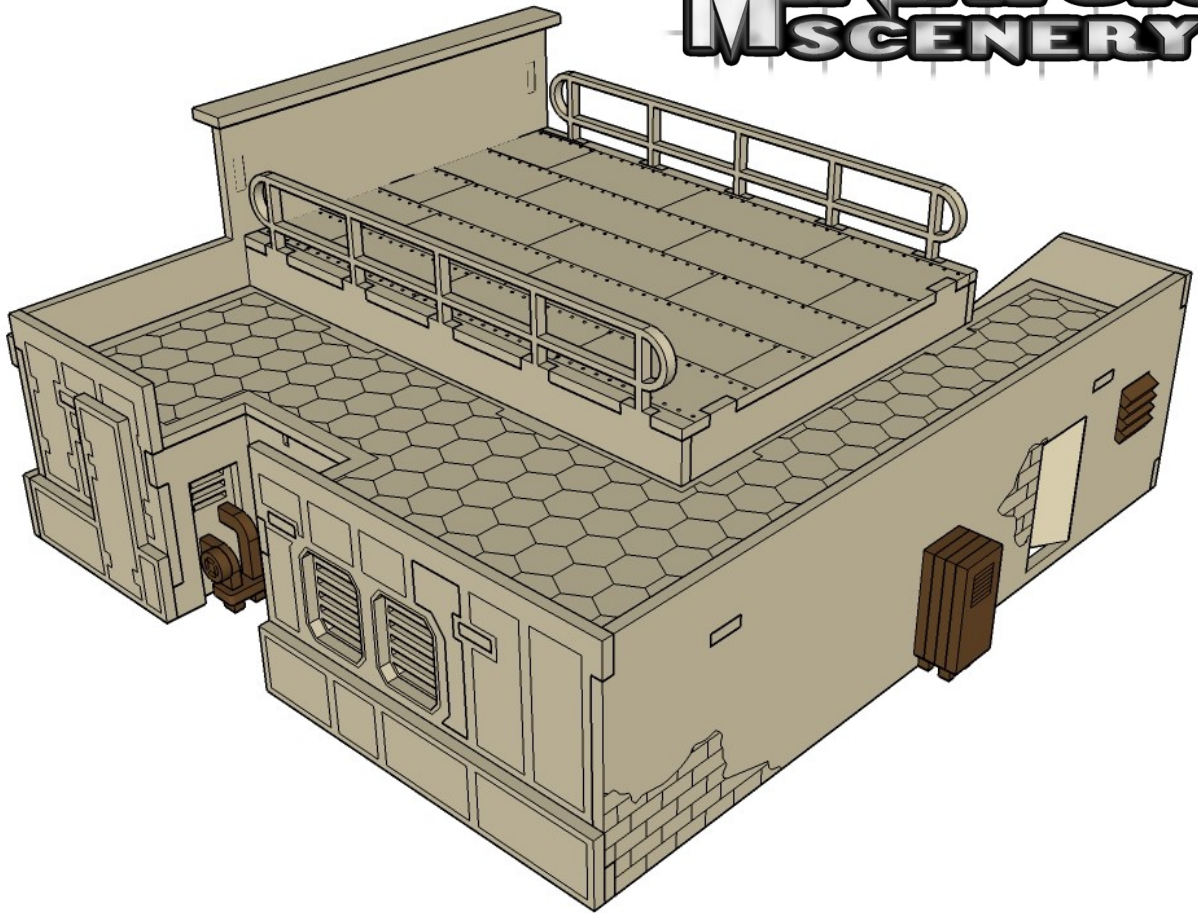



CNC WORKSHOP

# MINIATURE SCENERY

