

Preparation

Once you clear some table space you will need a pair of side cutters and glue (PVA, wood glue, hobby glue). A file or small piece of sandpaper can be used to clean along any edges that have bur.

Your model can hold together without glue, so you may wish to assemble it initially, to familiarise yourself with how the pieces fit together.

Getting Started

- i. Remove all the parts out of the board with your cutters.
- ii. Go over each part again with the cutters removing as much of the tabs as possible (this greatly reduces the time needed with the file or sand paper).
- iii. Use a file or sand paper last to completely remove the tabs that might remain.

Construction

Slot the parts together as shown by the pictures below, applying glue wherever there is a connection.

Allow the model to completely dry before painting it.

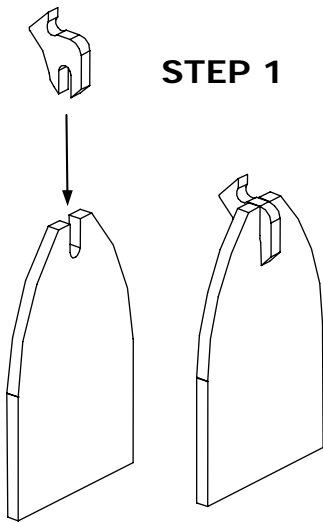

STEP 1

Attaching the Arch Walls

The Arch Walls can hold onto a Fortress/Pantheon model without glue. They can be added or removed as needed to suit your scenario.

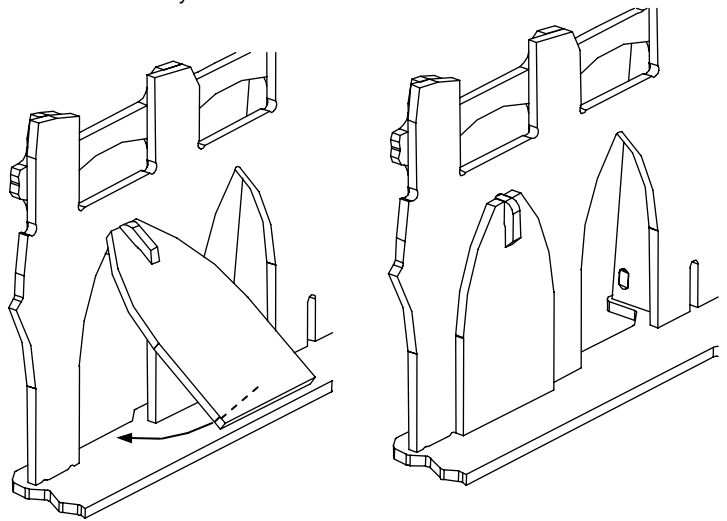

PAINTING

At www.miniaturescenery.com we provide a detailed and easy to follow illustrated guide for painting each series. We also share simple, effective painting techniques that you can use to get your model looking its best.



Your model has a 'jigsaw' like connection that allows it to join up with other Fortress models. This type of connection does not require glue.

SCENARIO CREATION



The Fortress/Pantheon Series consists of 4 model types that can be combined to form various scenarios from a complete fortress, temple or palace – to a compilation of scattered city ruins.

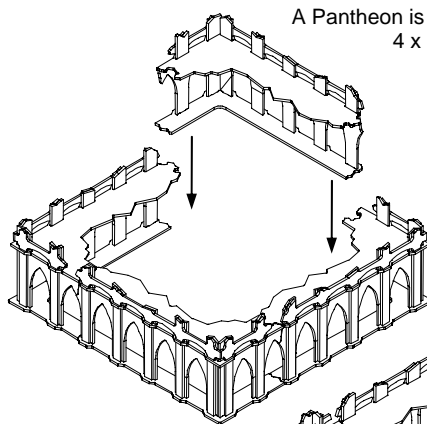
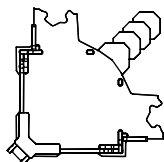
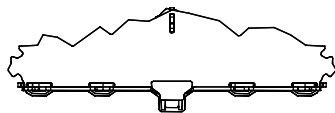
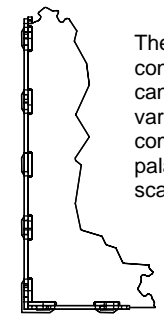

A Pantheon is built from:
4 x L-sections

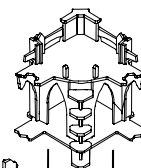

A large sized fortress is built from:
4 x Corners
3 x Straights
1 x Arch wall set (30)
1 x Entrance

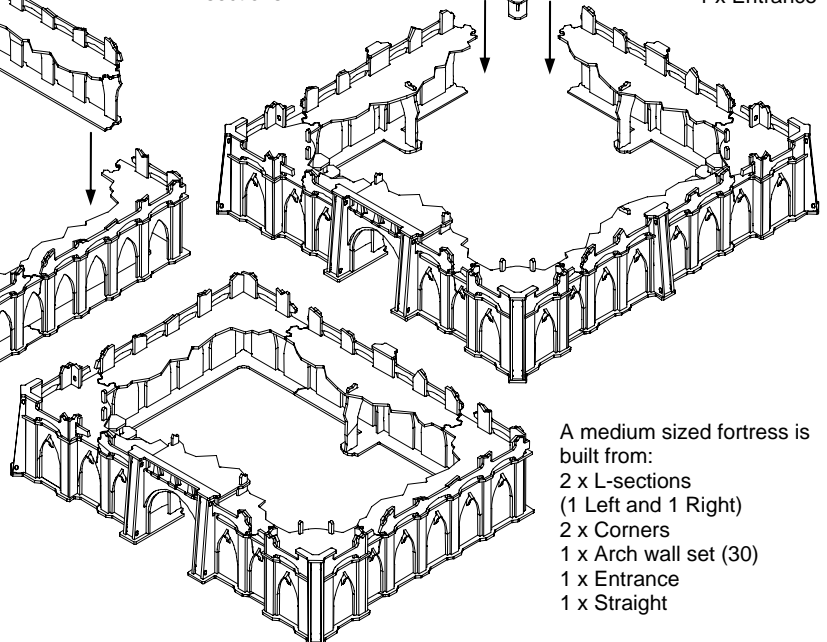

A medium sized fortress is built from:
2 x L-sections (1 Left and 1 Right)
2 x Corners
1 x Arch wall set (30)
1 x Entrance
1 x Straight