

MINIATURE SCENERY

PORTABLE WORKSTATION



INCLUDES
Cutting Mat
See reverse
for colour

OPTION LEFT

OPTION RIGHT



Item Shelf
- Device Holder
- Hidden Drawer



Bits Storage
- Two Tiers
- Removable Separators



Large Paint Rack
- Citadel/P3 Paints
- Max 33mm Diameter



Dropper Bottle Rack
- Vellejo / Army Painter
- Max 26mm Diameter



NOT INCLUDED: Phone, Tools, Models, Pen, Plastic Cup or anything other than MDF or cutting mat



FOR DETAILED, EASY TO FOLLOW INSTRUCTIONS VISIT
WWW.MINIATURESCENERY.COM

Contents may contain small parts. Not suitable for children under 6 years old. The exclusive copyright on the model designs and components within this case is the property of Miniature Scenery, 2018. All rights reserved.

MINIATURE SCENERY

INSTRUCTIONS WORKSTATION KIT

PREPARATION

You will need:

- Cutting mat or something to protect your table.
- PVA/Wood glue or superglue if you prefer.
- Small file or sand paper.
- Small blade / hobby knife



GENERAL PROCESS

- Clear plenty of table space, you will need it.
- Parts should remove easily from the board by pressing through and popping them out. It's a good idea to cut through the tiny joins first though, and some parts (particularly smaller, more detailed parts) may need more careful persuasion.
- Use file or sand paper to remove the small bur caused by the connection to the frame.
- It's a good idea to familiarise yourself with how the pieces fit together before gluing.
- Slot the parts together as shown by the pictures below, applying glue wherever there is a connection. (unless shown otherwise)
- Parts may be a very tight fit, slight trimming or sanding of parts may be needed for ease of assembly.



DO NOT GLUE



APPLY GLUE WHERE INDICATED

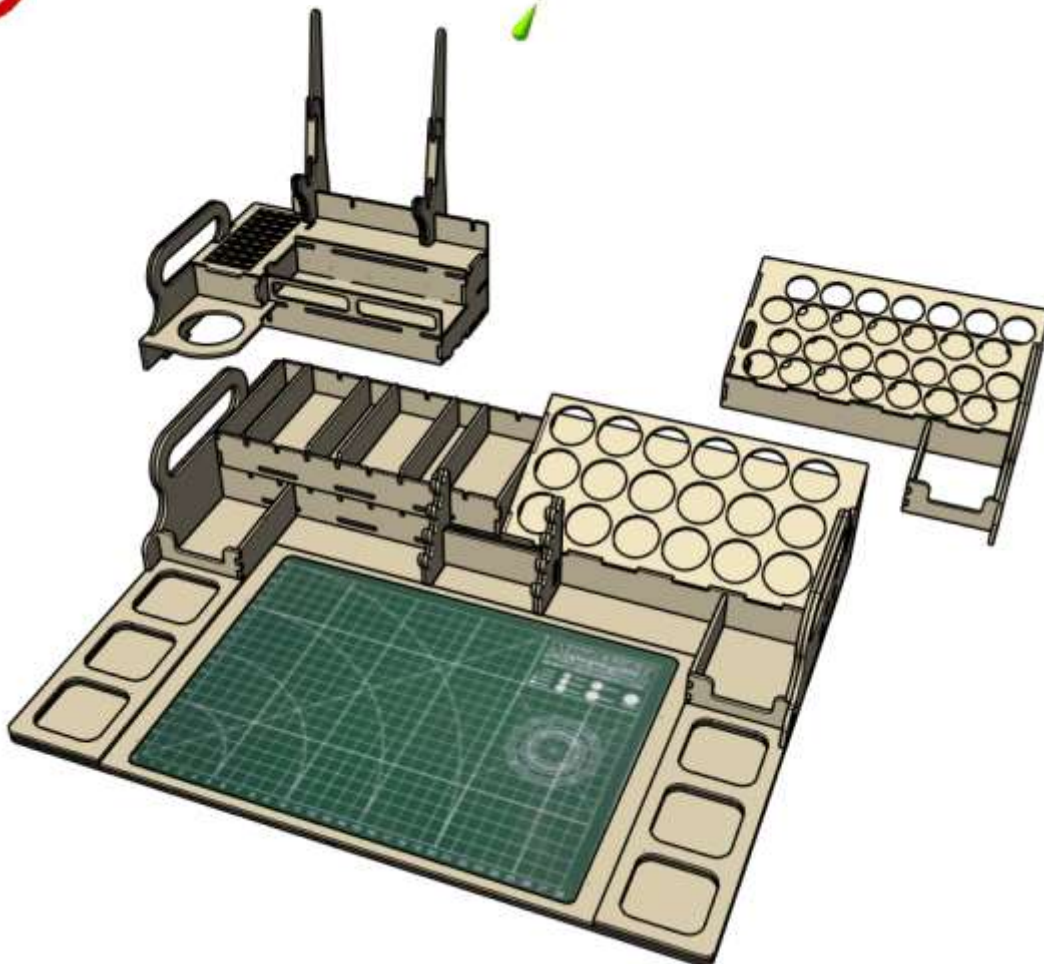

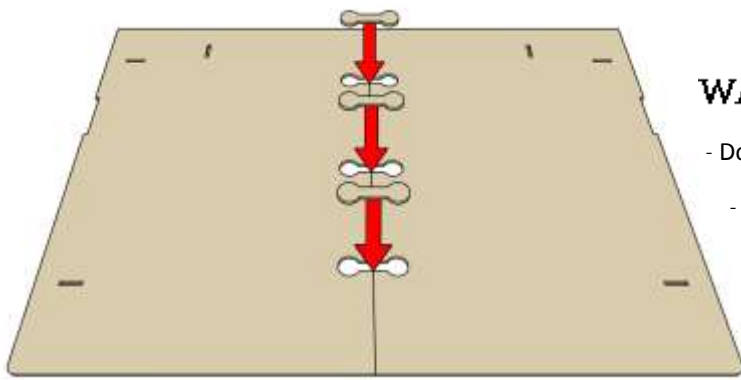

WARNING

- Do not glue the base to the table!
- Gluing the workstation to the table makes it a lot less portable

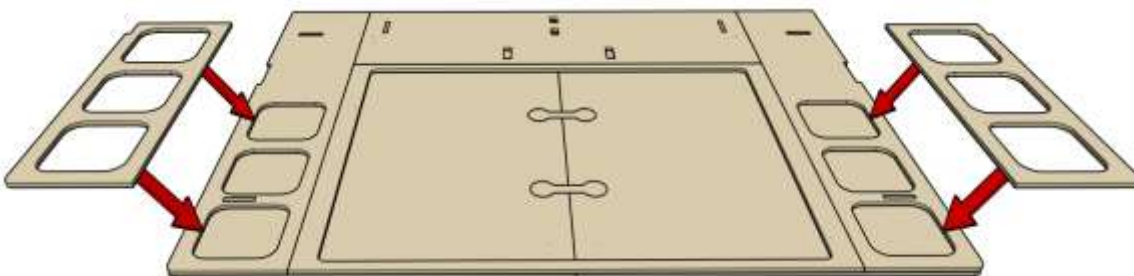
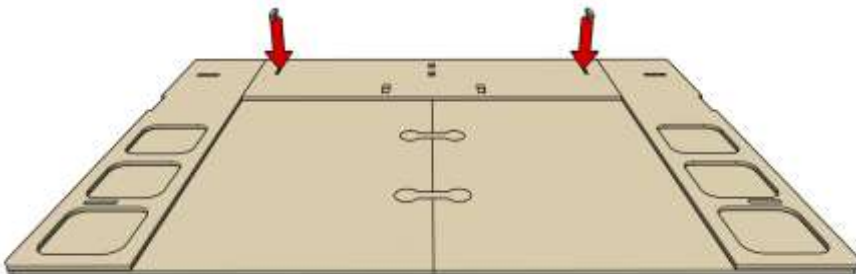
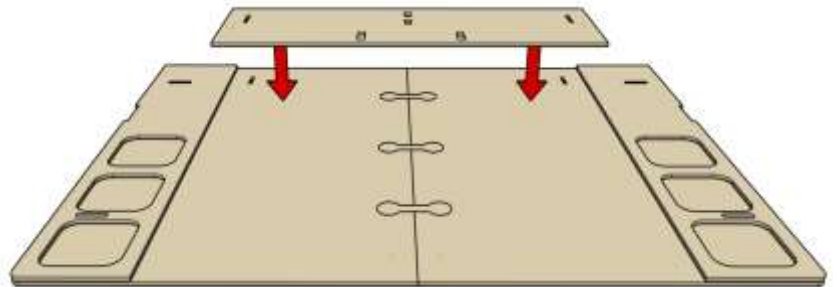
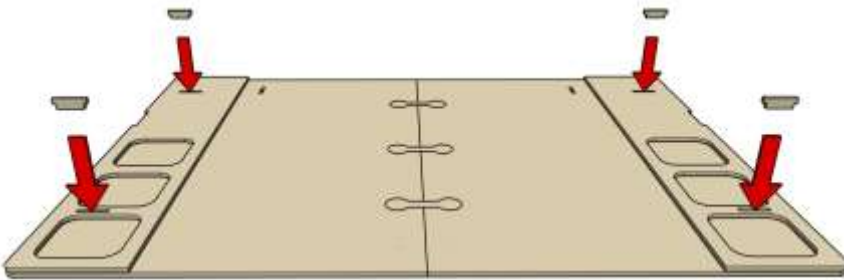
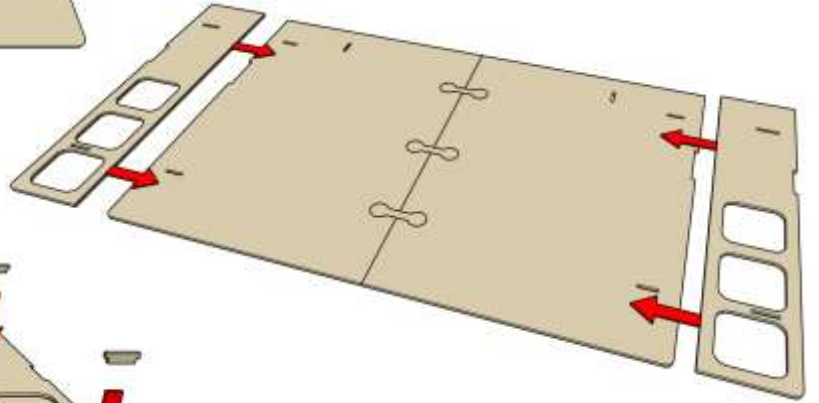

**LEFT SIDE
SHELF**

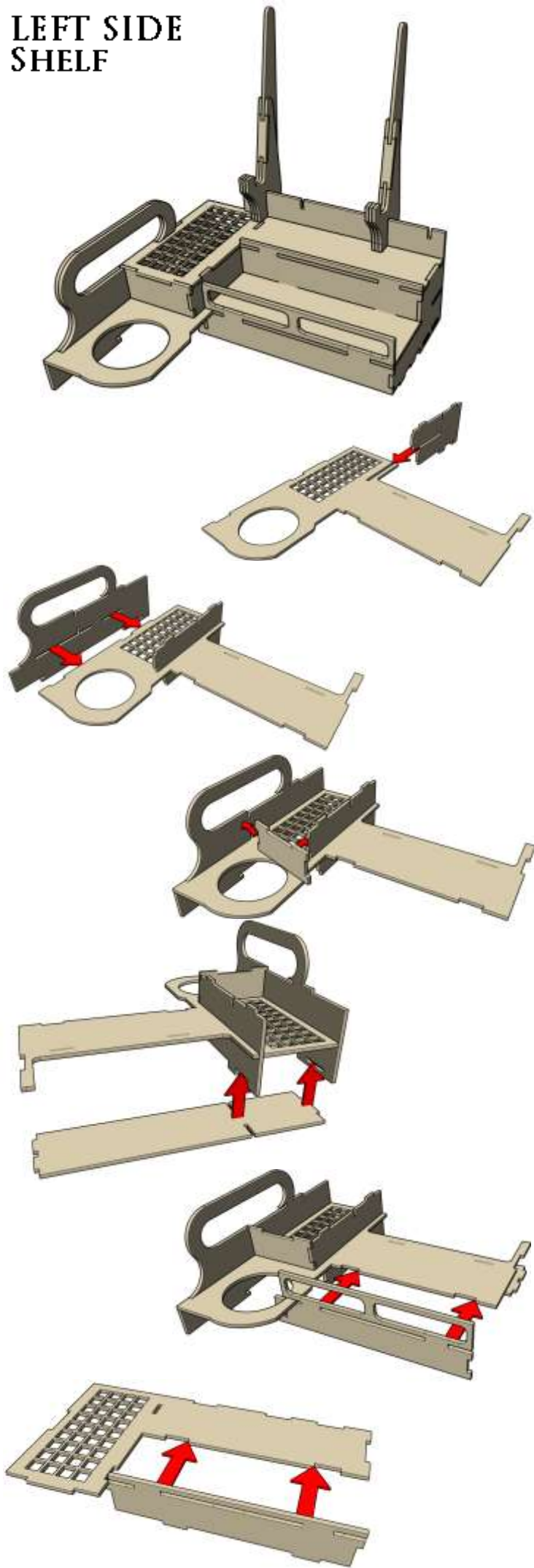

**RIGHT SIDE
SHELF**

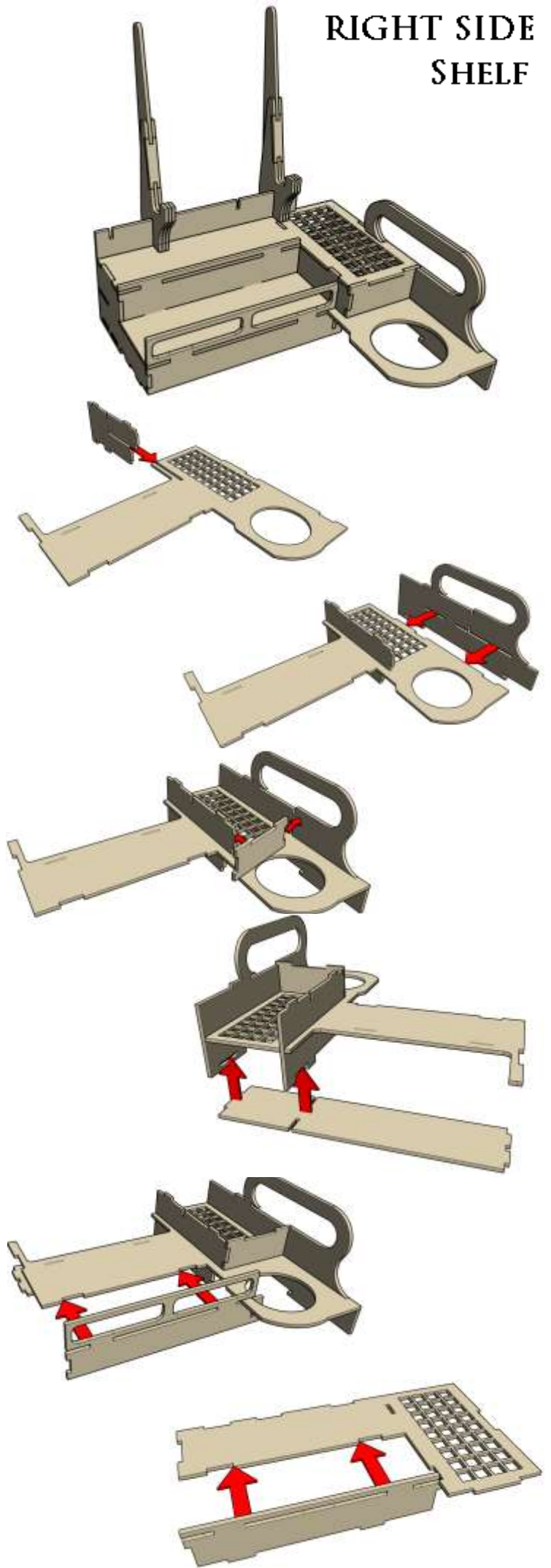

LEFT SIDE SHELF

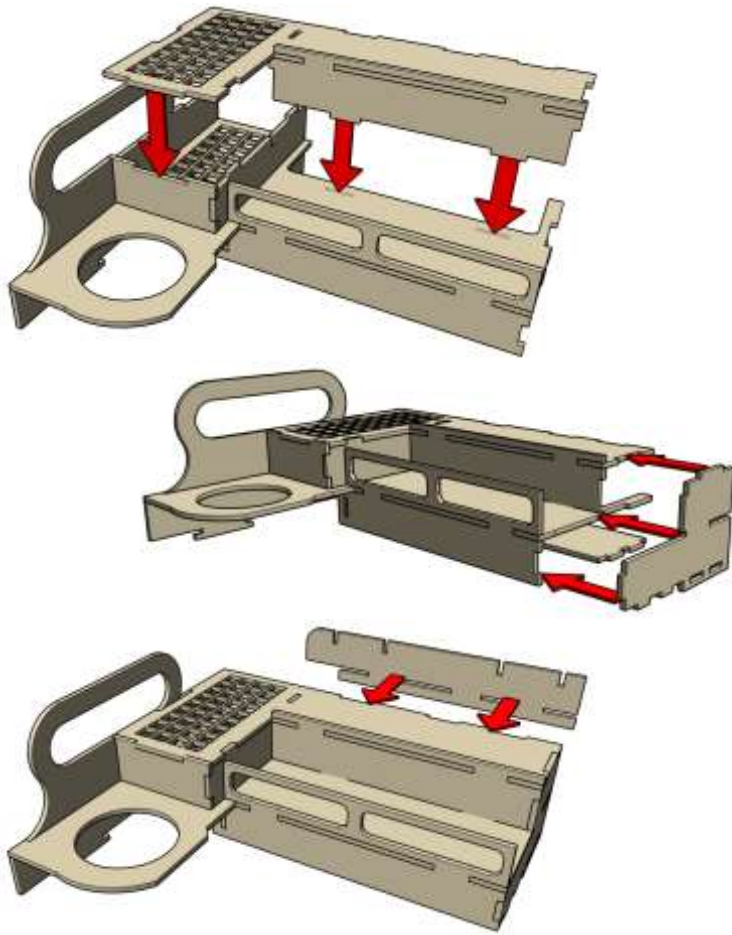

RIGHT SIDE SHELF

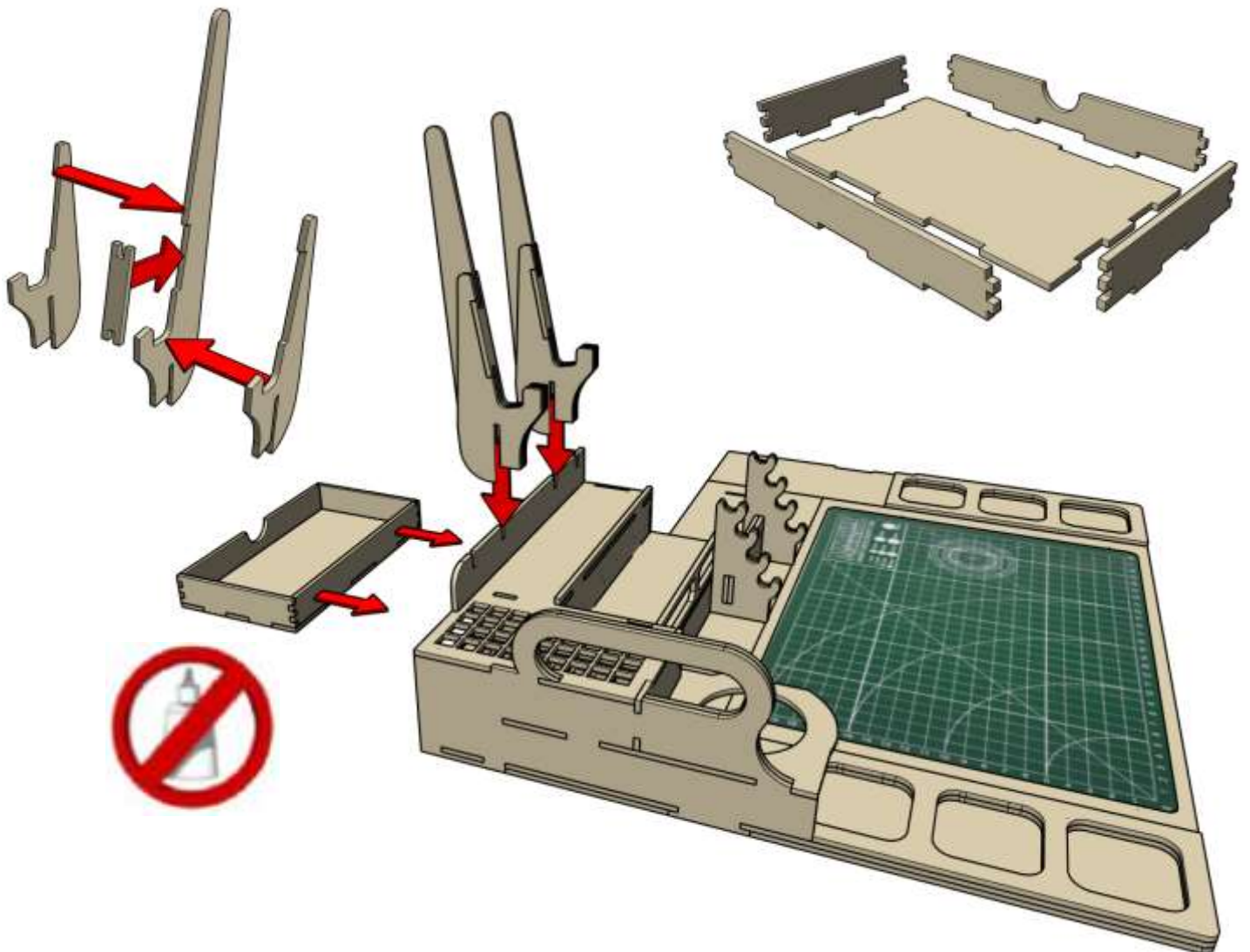
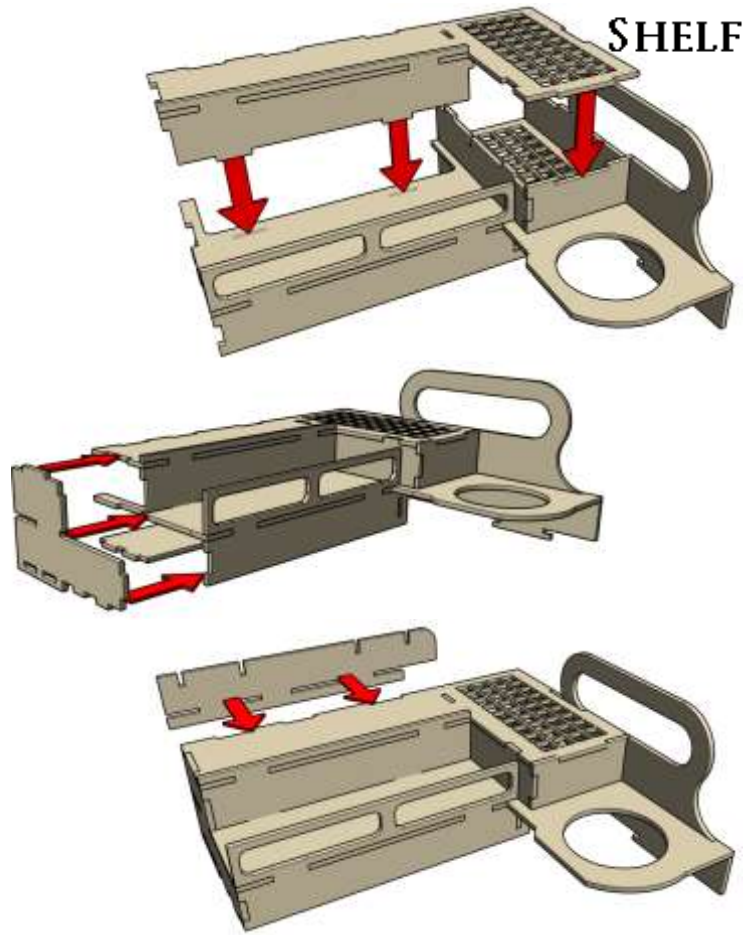

LEFT SIDE
DROPPER

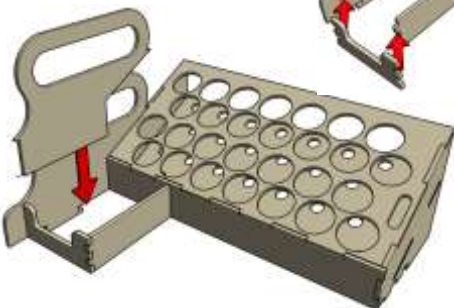
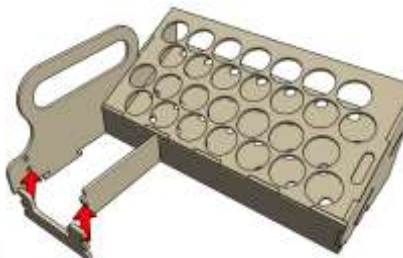
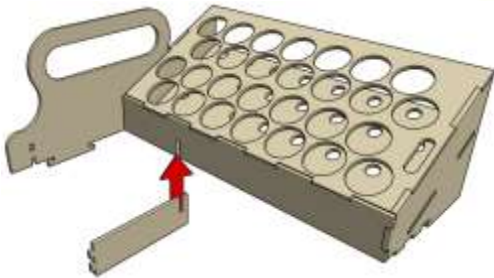
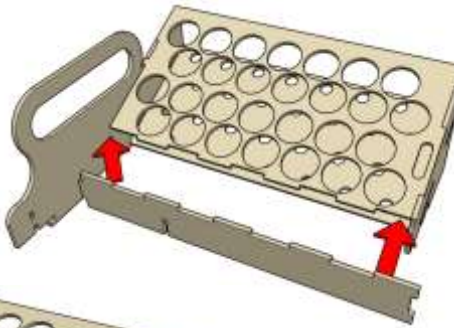
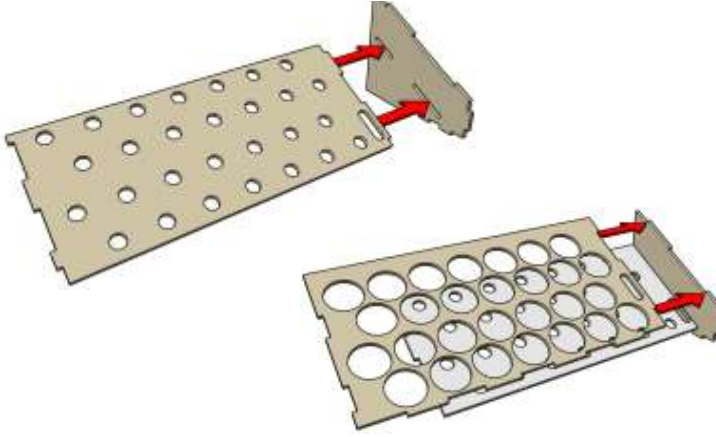

RIGHT SIDE
DROPPER

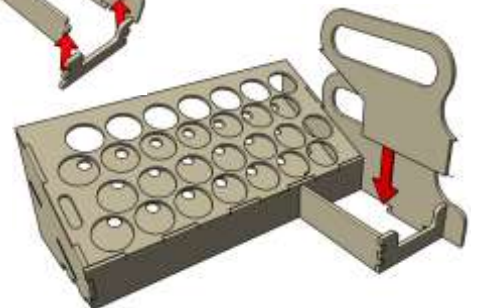
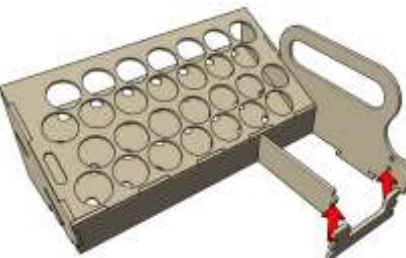
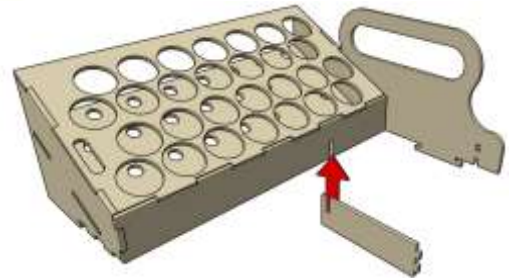
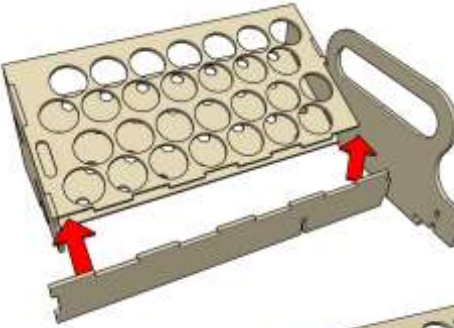
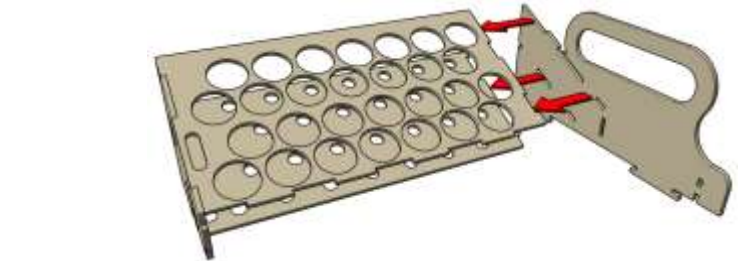
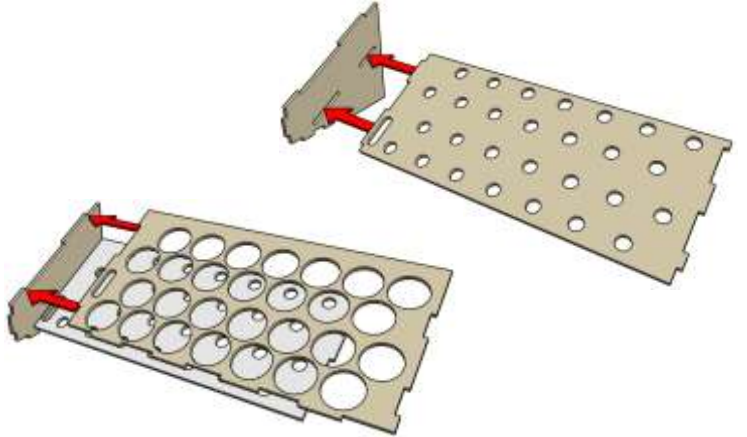

LEFT SIDE
TUBS

RIGHT SIDE
TUBS

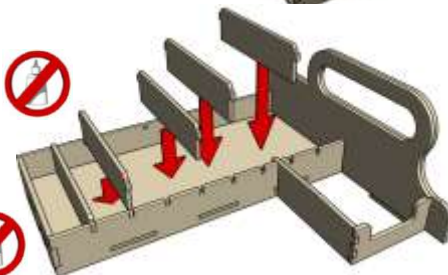
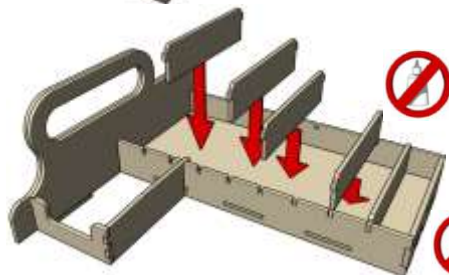
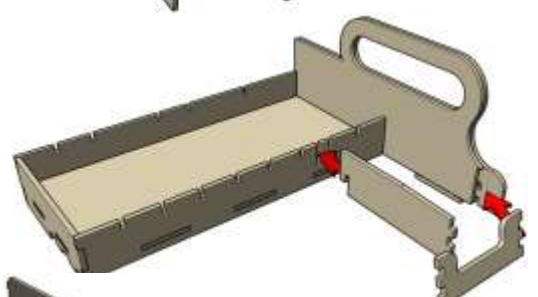
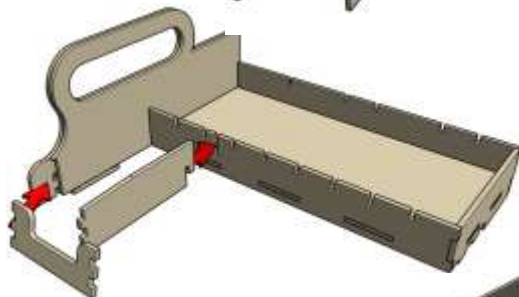
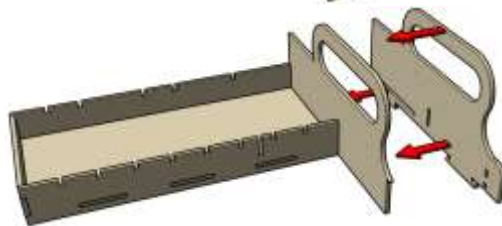
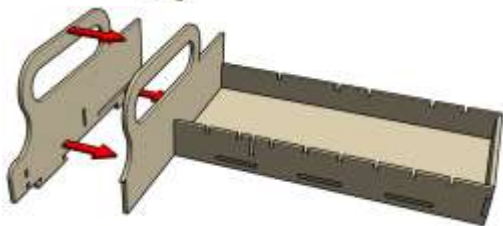
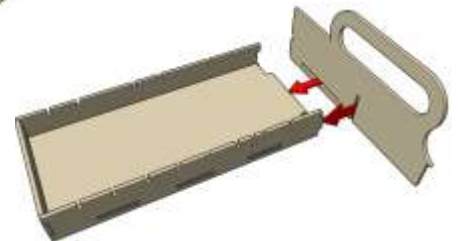
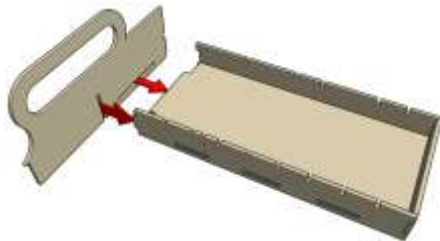
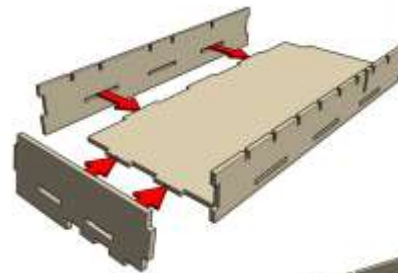
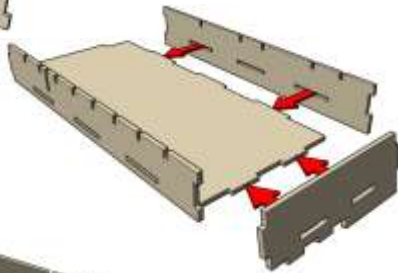
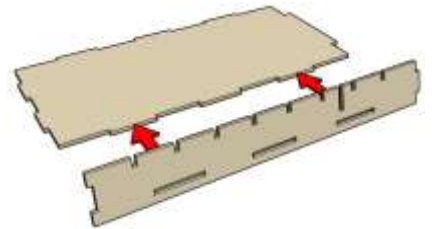
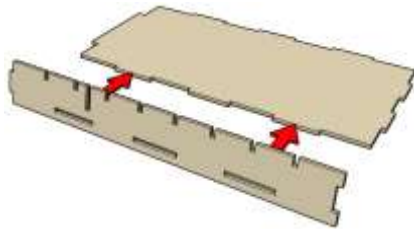
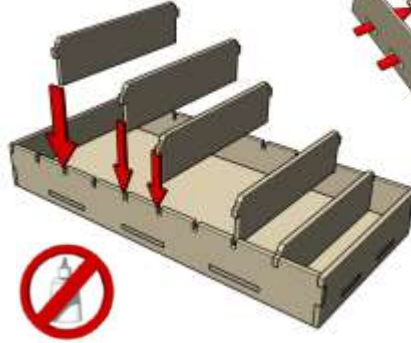
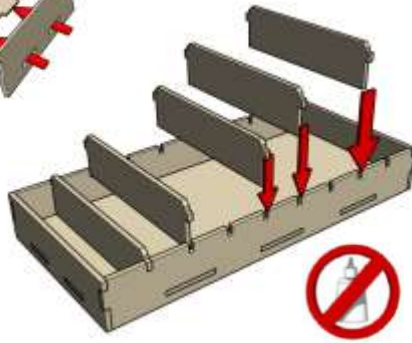
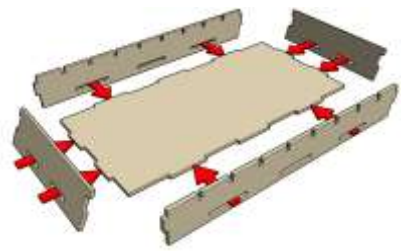
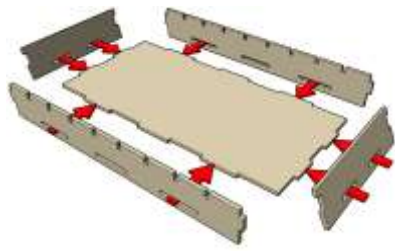
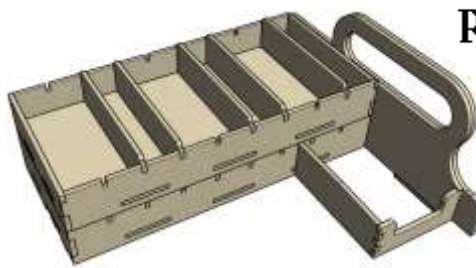
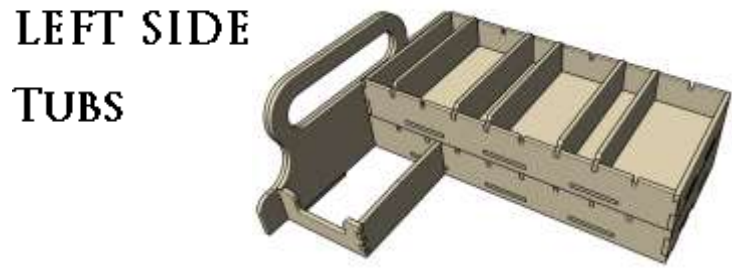

LEFT SIDE

PAINT

RACK

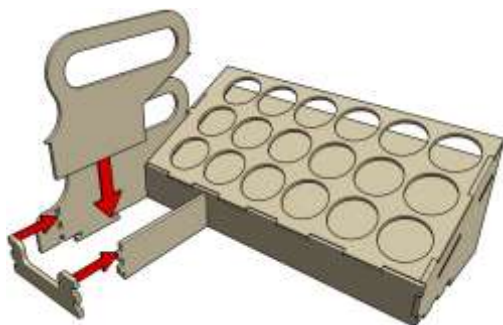
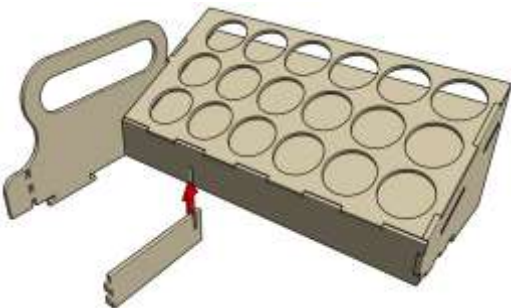
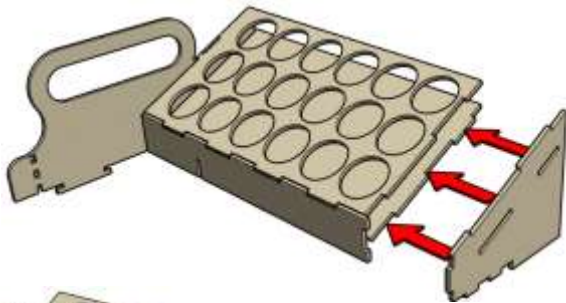
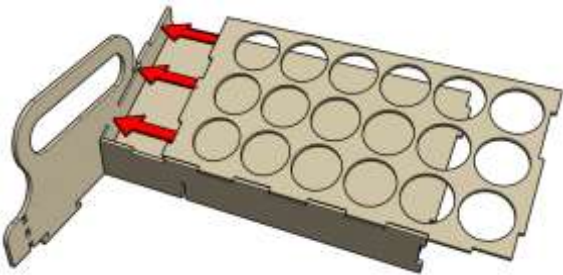
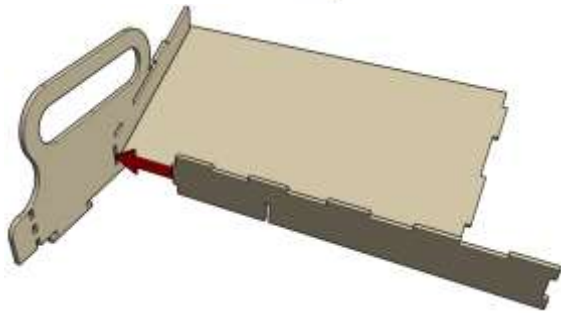
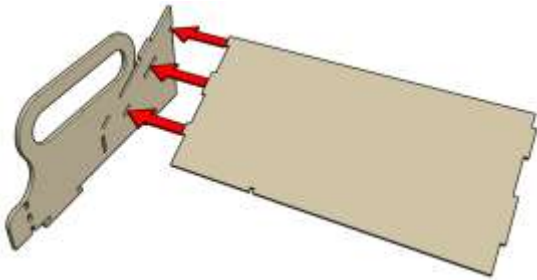
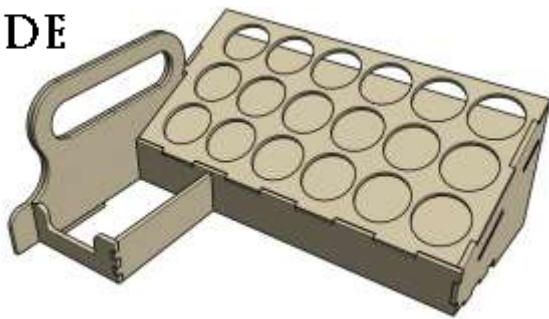

RIGHT SIDE

PAINT

RACK

