

CNC WORKSHOP

# MINIATURE

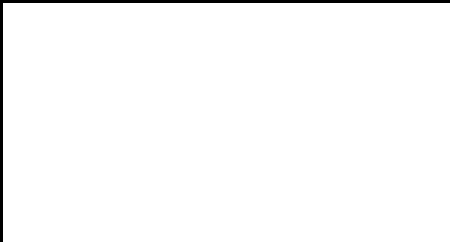

# CNC WORKSHOP MINIATURE SCENERY

## INSTRUCTIONS

### Frontier Objectives

#### Preparation

Once you clear some table space you will need a hobby knife and glue (PVA, wood glue, hobby glue) and a file or small piece of sandpaper to be used for cleaning up any tiny imperfections.

It's a good idea to familiarise yourself with how the pieces fit together before gluing.

#### Getting Started

I. Parts should remove easily from the board by pressing through and popping them out. It's a good idea to cut through the tiny joins first though, and some parts (particularly smaller, more detailed parts) may need more careful persuasion.

II. Use a file or sand paper last to completely remove the tabs that might remain.

III. Parts may be a very tight fit, slight trimming or sanding of parts may be needed for ease of assembly.

#### Construction

Slot the parts together as shown by the pictures below, applying glue wherever there is a connection.

Allow the model to completely dry before painting it. This may be a complex kit with many small parts. Allowing each section to dry thoroughly before heading to the next is strongly recommended.

Some parts of this kit are very fine, or have engraving very close to edges. Make sure you cut through any tabs carefully with a hobby knife first to avoid damage.

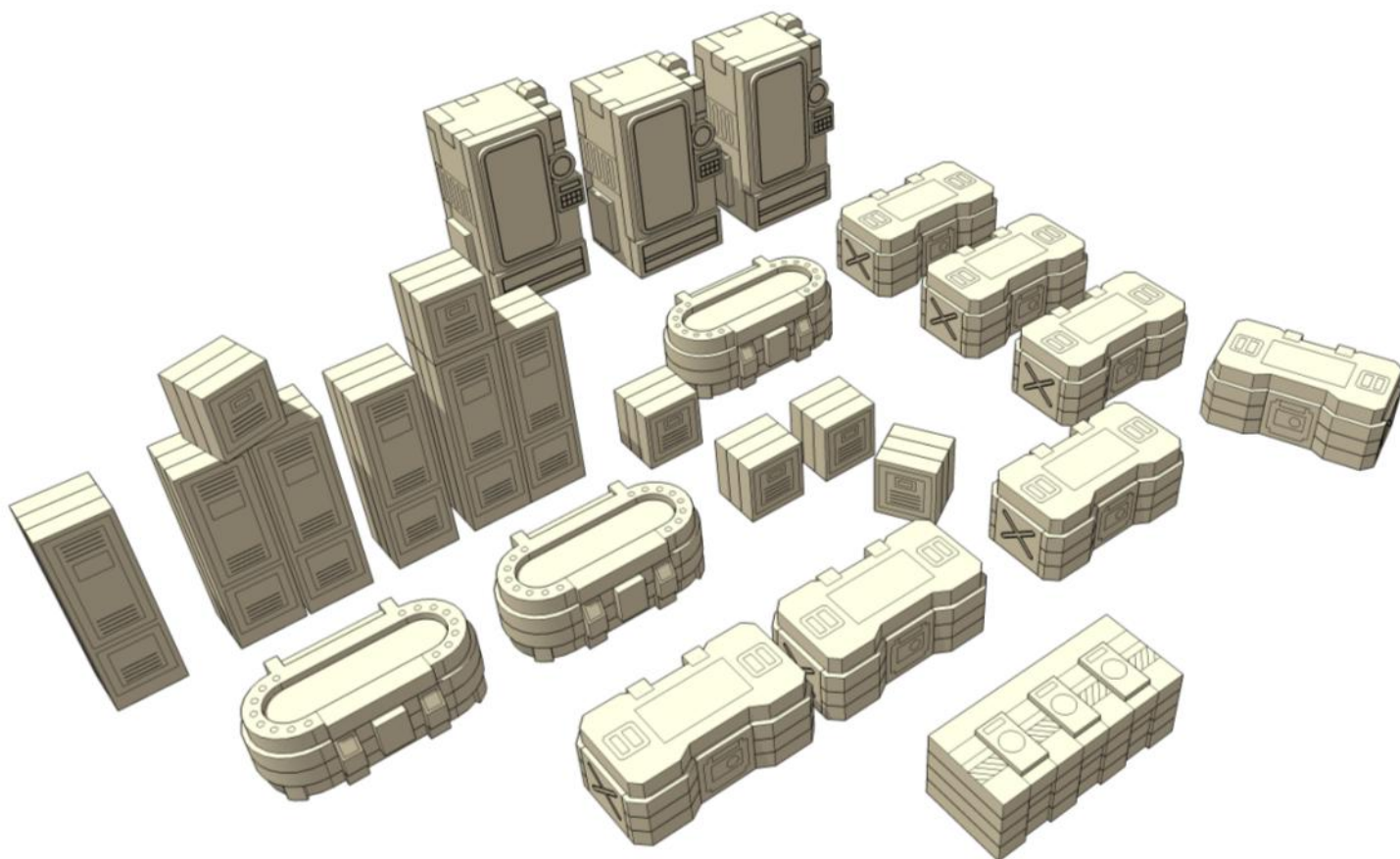

# MINIATURE SCENERY

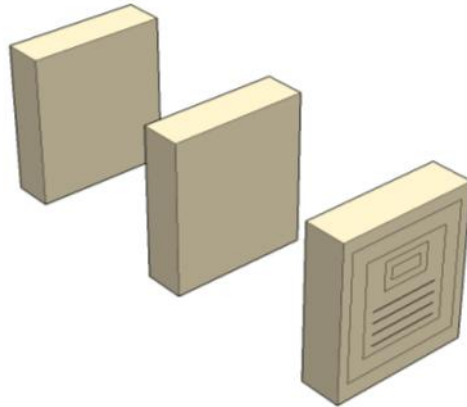
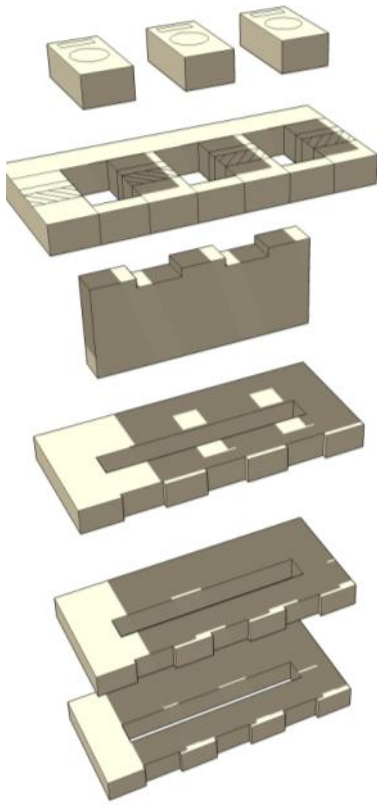

Use a toothpick for a hinge.

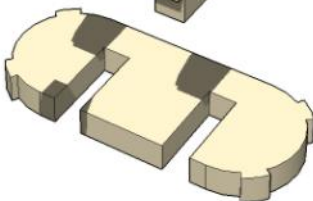
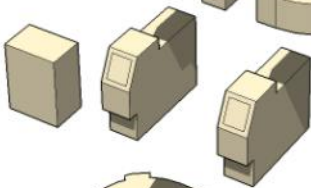
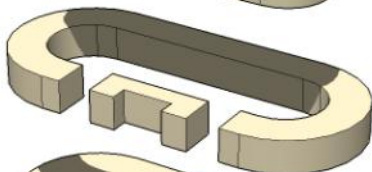
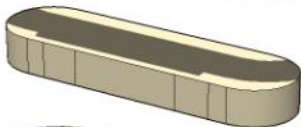
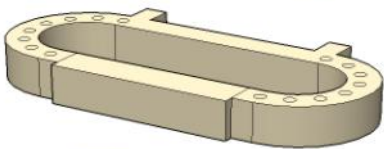
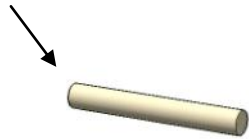

TIP: Instead of trying to remove the edges where the layers join by filling and sanding, Cut a strip of stiff paper the required width and wrap/glue it around the completed assembly.

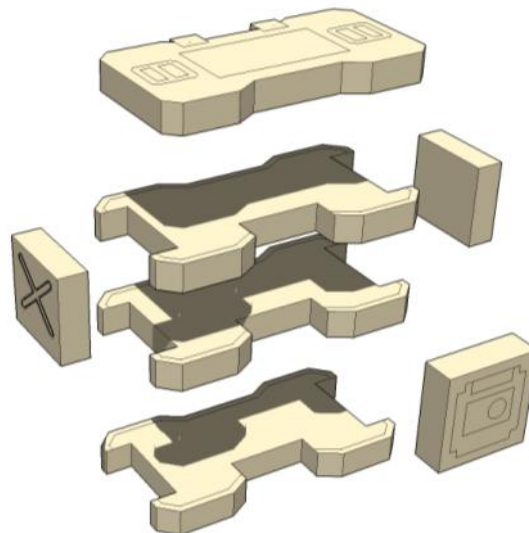
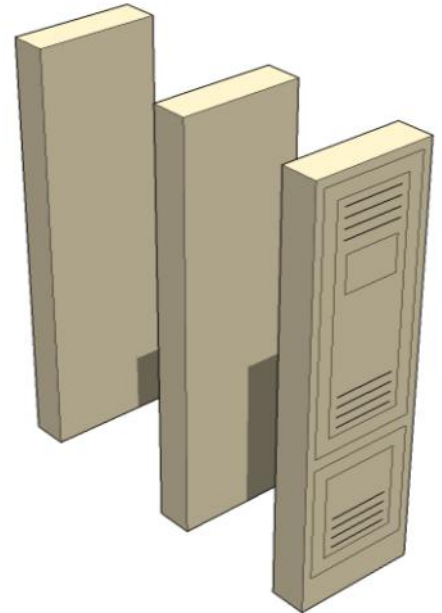

CNC WORKSHOP

# MINIATURE SCENERY

