

MINIATURE SCENERY

INSTRUCTIONS ORK-STERMINATOR

PREPARATION

You will need:

- Cutting mat or something to protect your table.
- PVA/Wood glue or superglue if you prefer.
- Small file or sand paper.
- Small blade / hobby knife

GENERAL PROCESS

- Clear plenty of table space, you will need it.
- Parts should remove easily from the board by pressing through and popping them out. It's a good idea to cut through the tiny joins first though, and some parts (particularly smaller, more detailed parts) may need more careful persuasion.
- Use file or sand paper to remove the small bur caused by the connection to the frame.
- It's a good idea to familiarise yourself with how the pieces fit together before gluing.
- Slot the parts together as shown by the pictures below, applying glue wherever there is a connection. (unless shown otherwise)
- Parts may be a very tight fit, slight trimming or sanding of parts may be needed for ease of assembly.

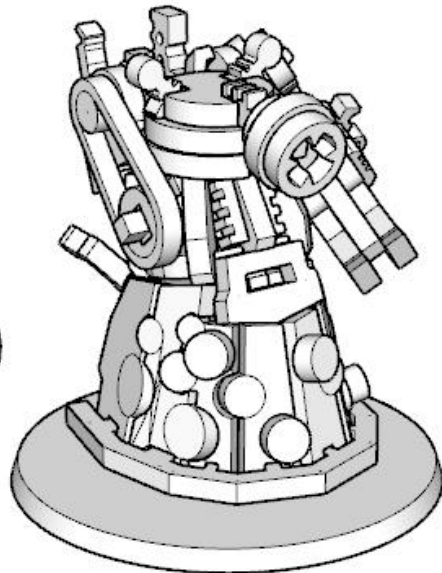
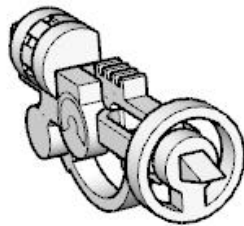
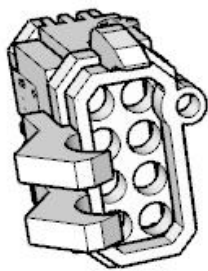

MINIATURE SCENERY

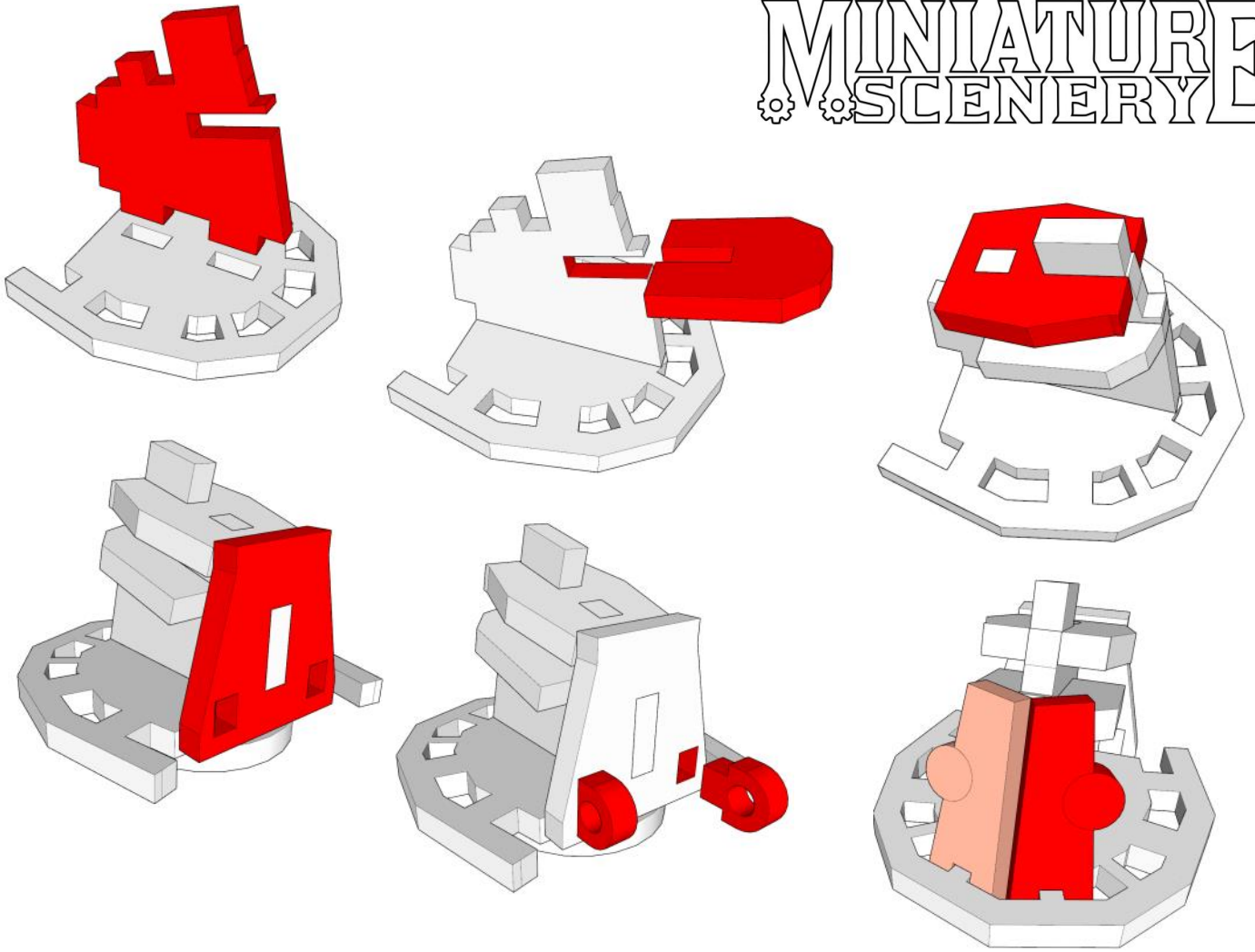

Panels Both Sides

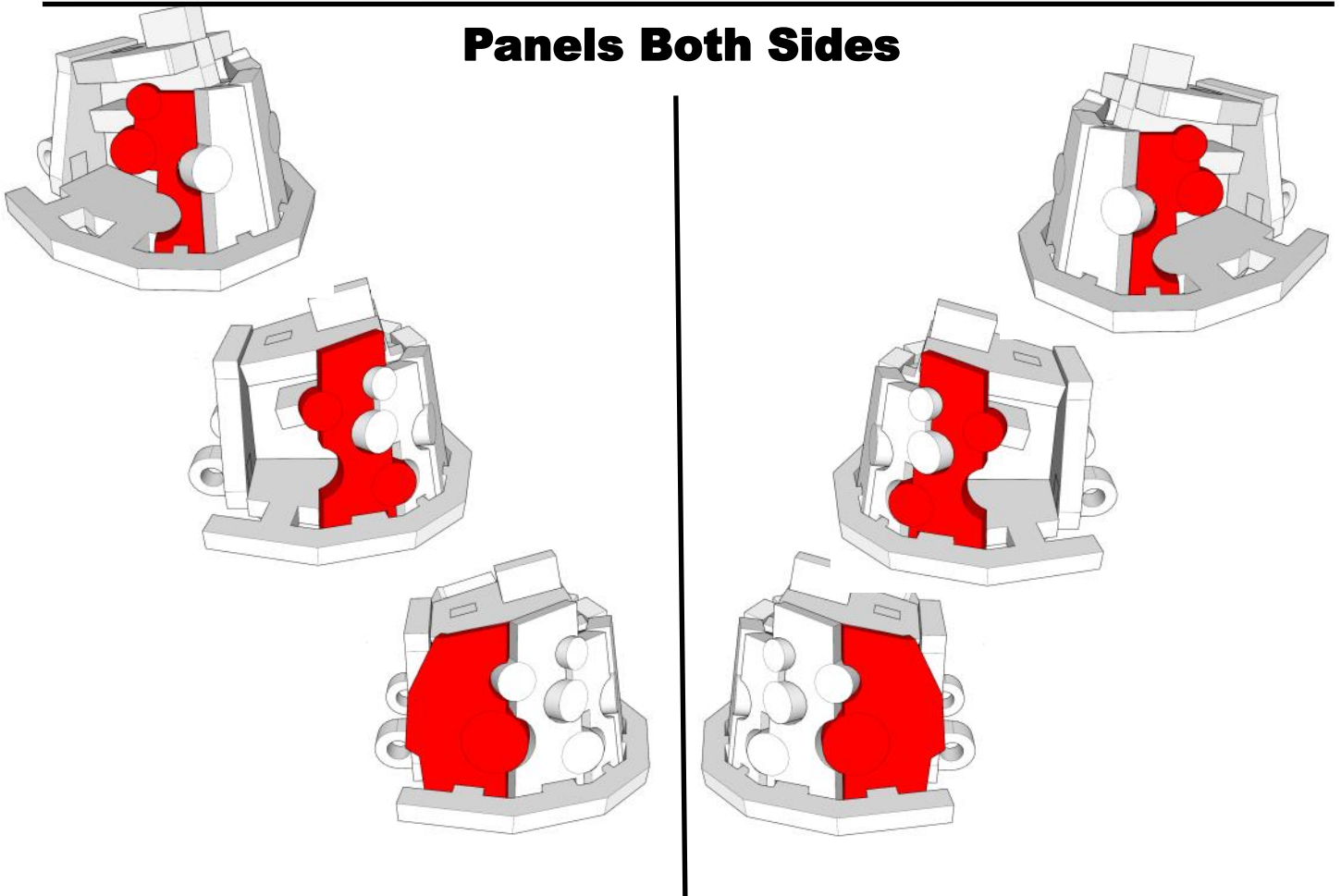

MINIATURE SCENERY

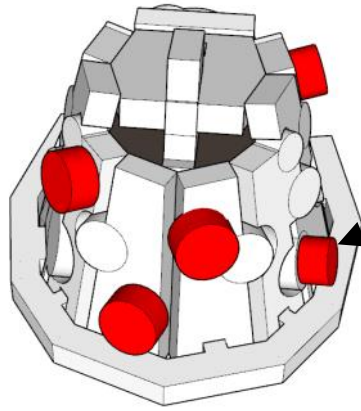
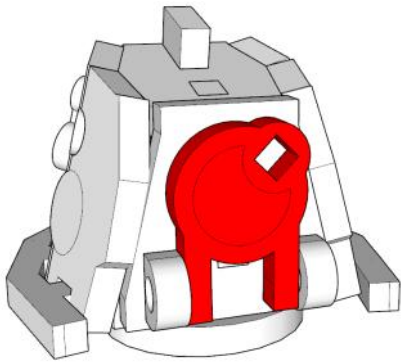

Dot gubbinz can go anywhere.

Lots spare, don't feel like you need them all.

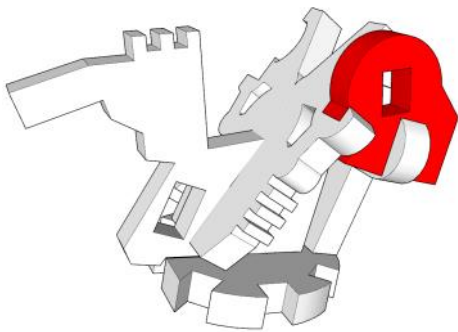
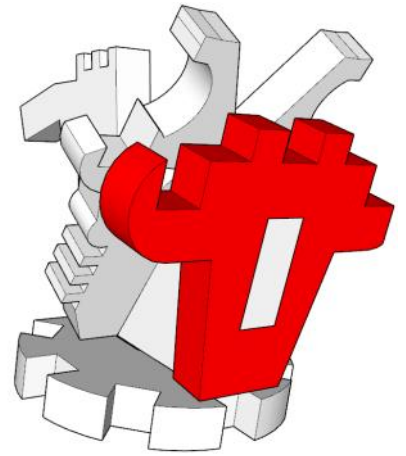
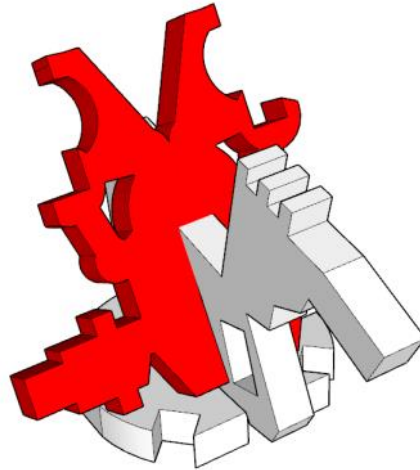
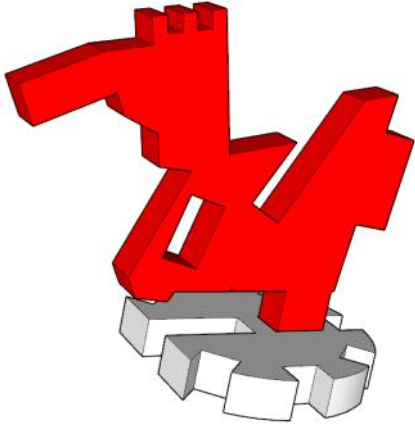

May need some wiggling

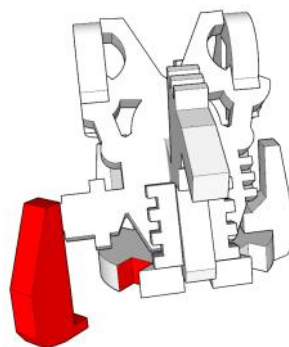
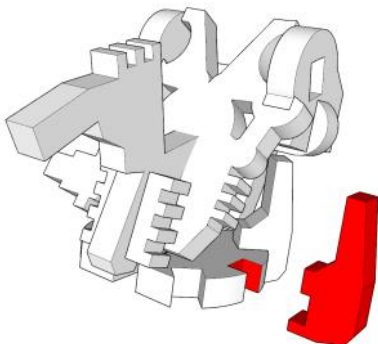
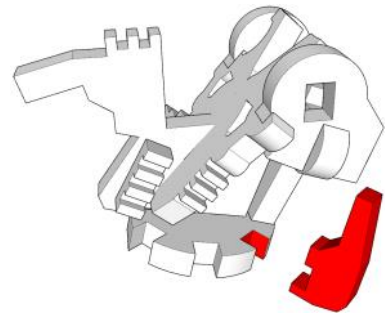
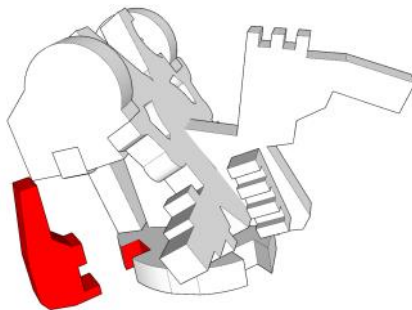
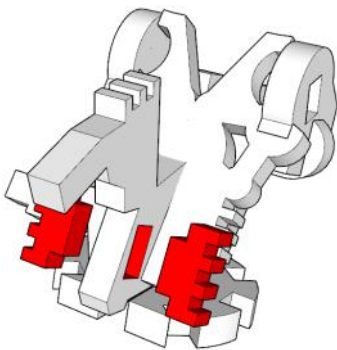
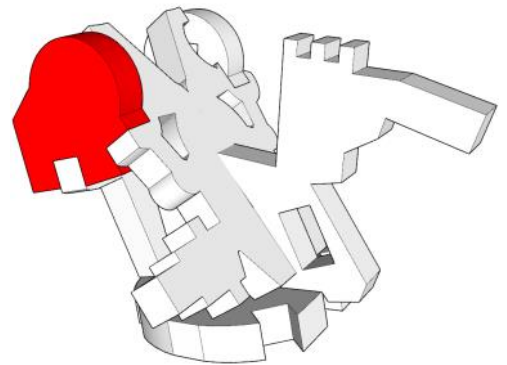

MINIATURE SCENERY

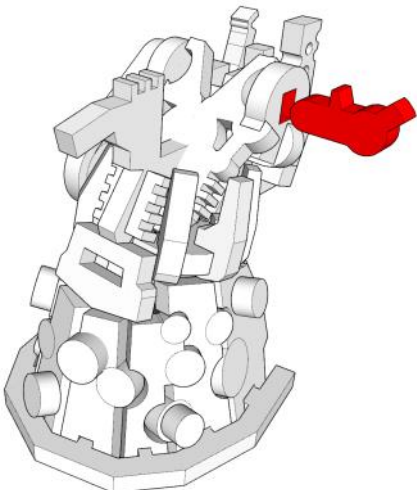
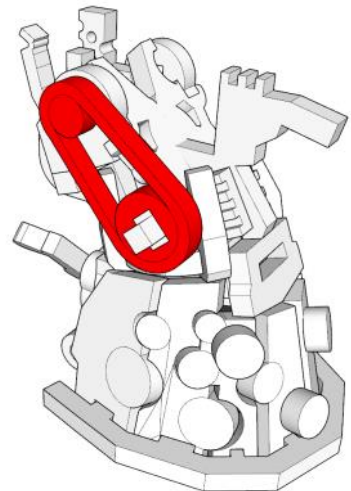
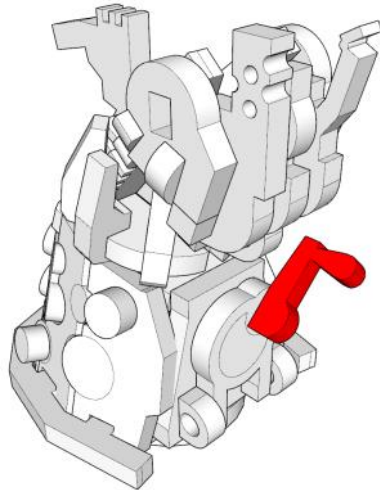
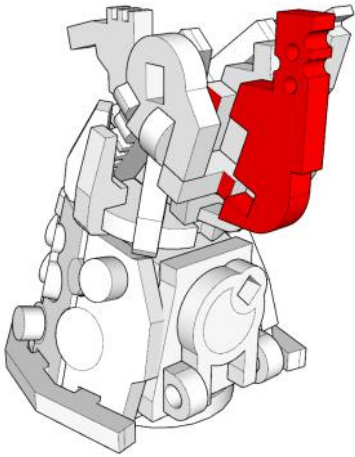
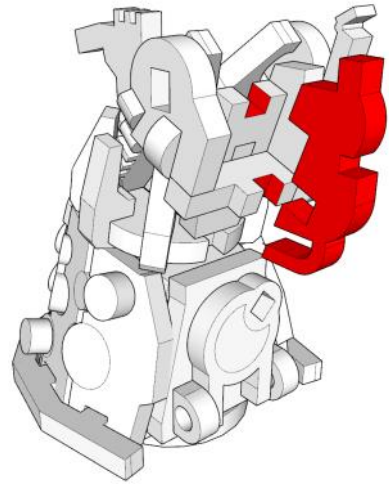
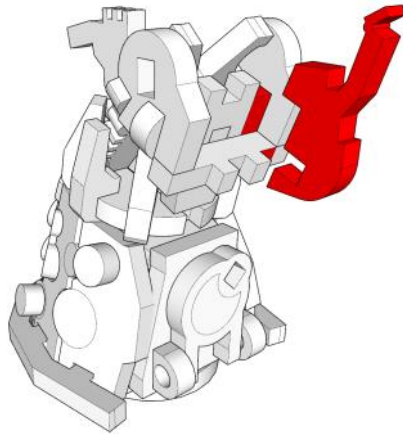
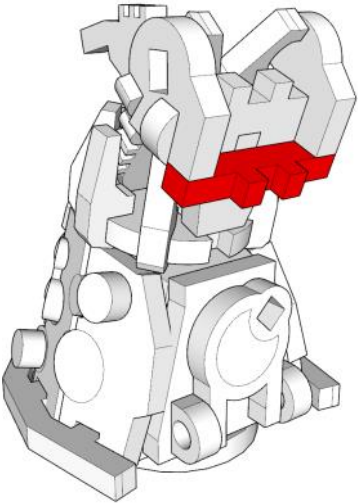
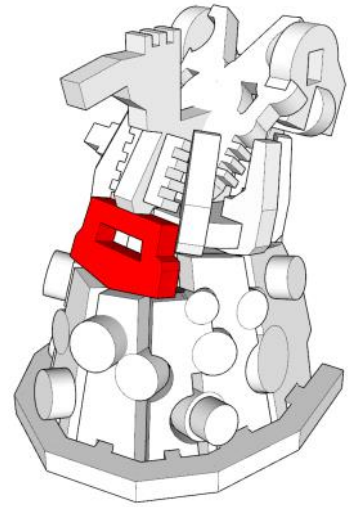
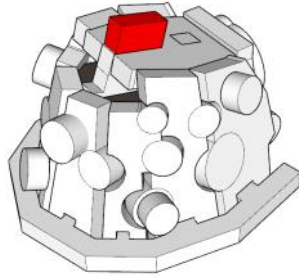
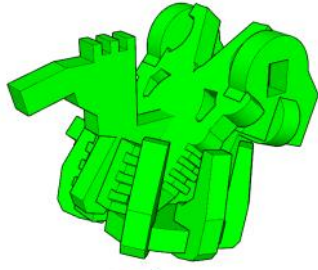
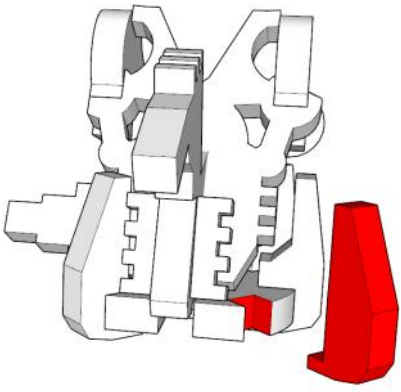

MINIATURE SCENERY

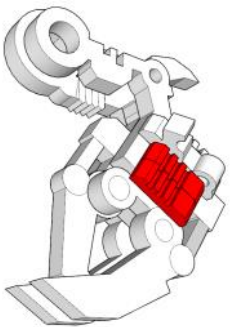
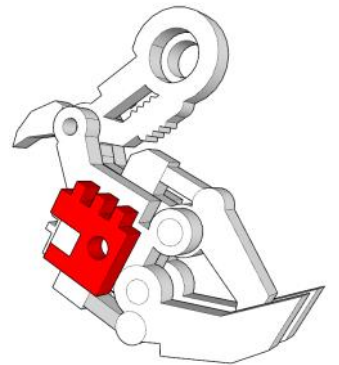
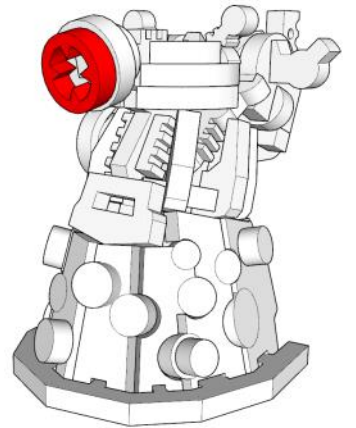
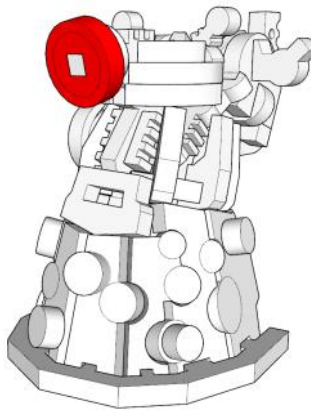
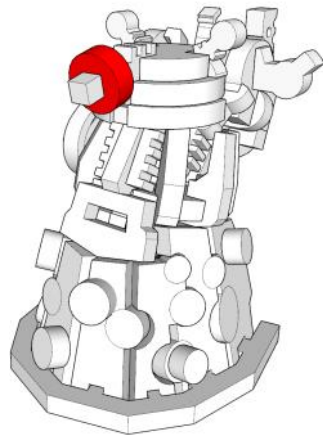
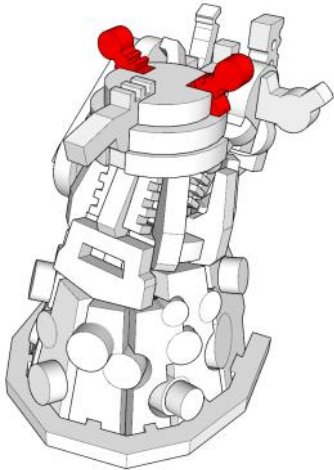
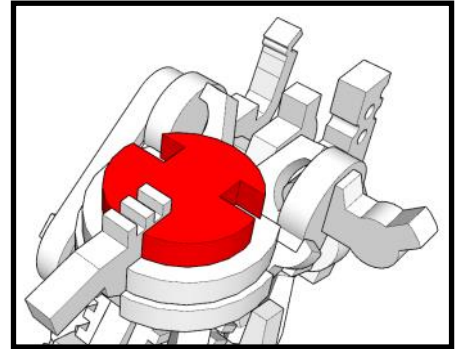
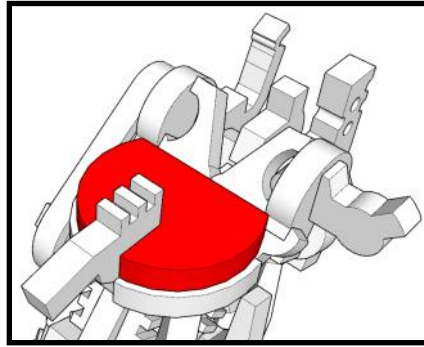
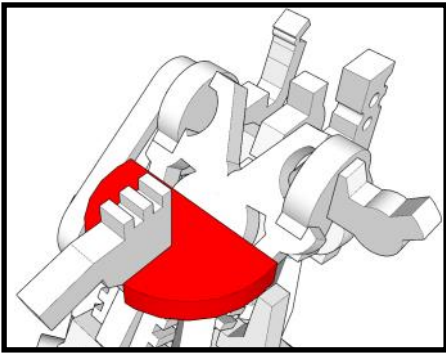

MINIATURE SCENERY

Careful to get this one the correct way

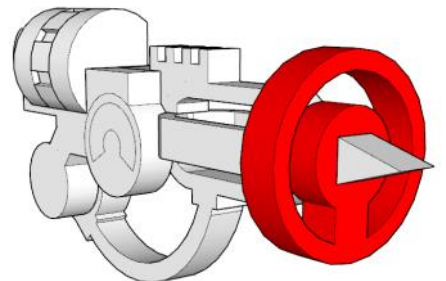
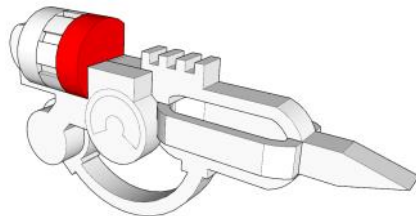
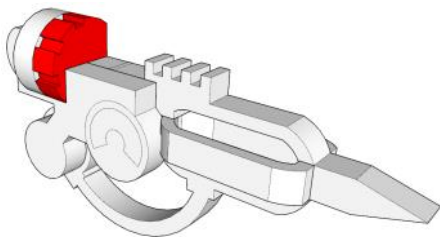
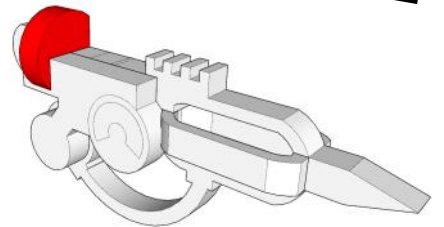
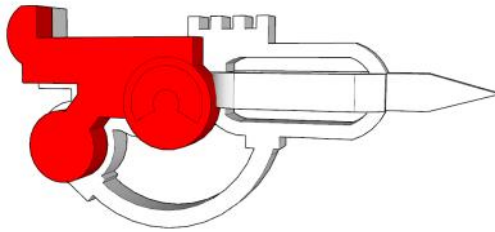
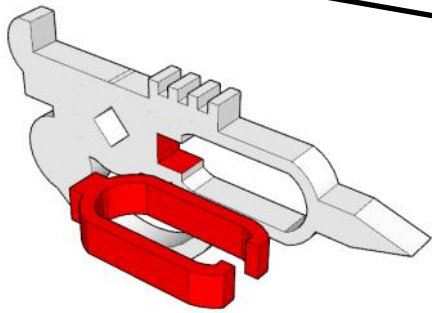
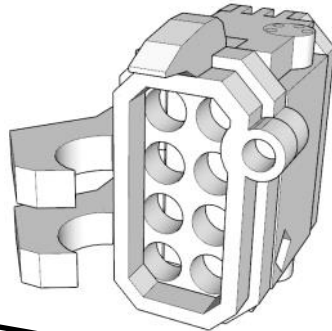
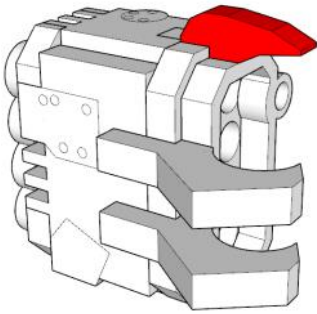
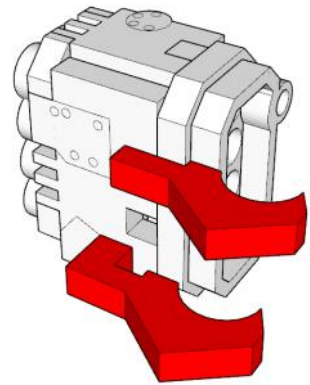
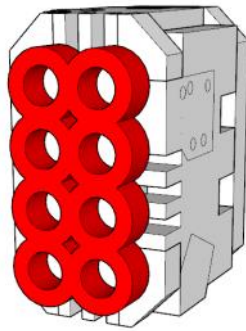
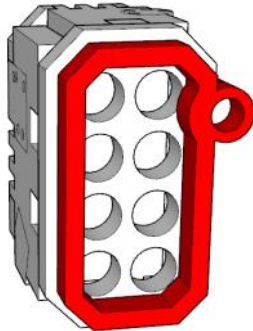
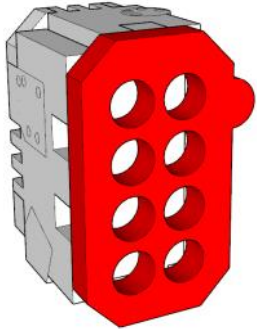
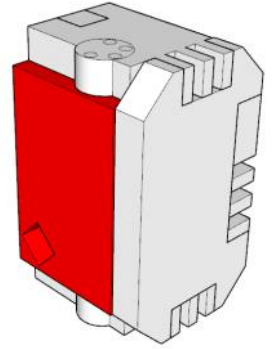
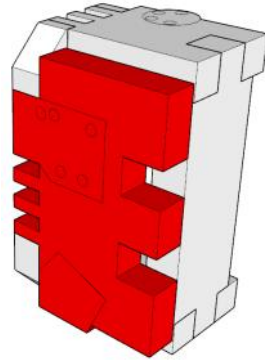
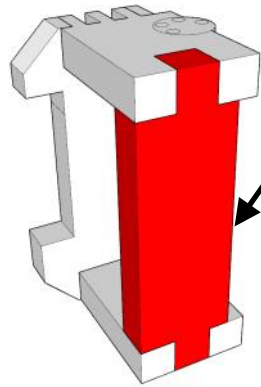
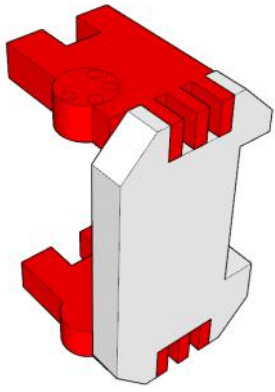

MINIATURE SCENERY

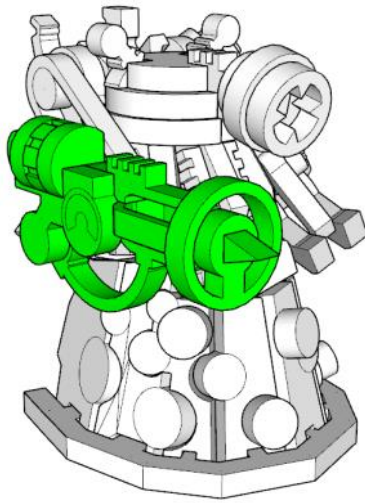
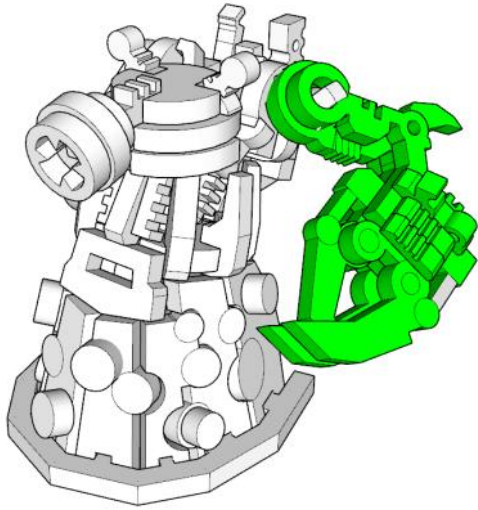

OR

